

KELLOGG

USE — is the Test

INTERIOR TELEPHONE SYSTEMS LINE CATALOG NO. 4 INSTALLATION INSTRUCTIONS BULLETIN NO. 15 1918

Complete line catalog for Kellogg's Interior Telephone Systems (Intercom) includes telephones, installation hardware, wire and battery systems. Also in this PDF is the installation instructions for these systems.

Produced in bound soft cover book form, 7 3/4 X 10 inches, 20# coated stock printed in one color by letterpress. The cover is printed two color silver and black on an 30# embossed cover stock.

Scanned from an original document furnished by Wayne Merit
JKL Museum of Telephony

www.johnlarue.net/cgi-bin/photos.isc

Adobe Document Produced by Mike Neale, Member of
Antique Telephone Collectors Association US
Telephone Collectors International US
Telecom Heritage Group UK

www.kelloggtelephone.com

Adobe Document Copyright 2006, Mike Neale, Midland, Texas, USA



www.atcaonline.com



www.telephonecollectors.org



www.thg.org.uk

Kellogg Automatic Interior Telephone Systems



Kellogg Switchboard & Supply Co.
Chicago

Catalogue Number Four

Kellogg Switchboard & Supply Co.
Chicago, U. S. A.



With Kellogg
Equipment



We have secured Grand Prizes and Gold Medals at the Paris, Milan, St. Louis and Buffalo Expositions as makers of the finest Telephone Equipment in the World.

The only exhibitions in which we did not win first prize were the ones in which we had no entry. Kellogg Apparatus is built up to a standard and not down to a price.



Use Is
The Test



TO THE PURCHASER

In presenting this catalog to our friends, and those who thru it will become our friends, we have endeavored to give a clear understanding, by illustration and description, of the Kellogg Automatic Interior Telephone Systems and Private Line Telephones.

We believe the function of a catalog is to present to the customer apparatus, information and prices in a concise and convenient form for quick reference. This necessitates abbreviation in illustration and description and if more information than given here is required, it will be gladly furnished on application.

GUARANTEE.

Kellogg apparatus is guaranteed to be free from mechanical and electrical defects for one year, and any part showing faulty manufacture during that period will be repaired or replaced without charge on being returned to this Company.

LIABILITY.

We exercise the utmost care in packing goods and cannot be held responsible for any damage to them while in transit. If such cases are reported to us we will gladly co-operate with our customers in securing an adjustment of all claims.

HOW TO ORDER.

It will enable us to make prompt shipments with less liability of error if the catalog code number and name of each article is given; also state whether shipment should be made by express, parcel post, or freight and if any preference for routing is desired.

RETURNING GOODS.

If orders are not specific we will write for further information, but when they are filled with goods called for, same cannot be returned without special agreement and a 10% service charge will be made on such goods. Also all returned goods must be in salable condition and transportation charges paid.

PRICES.

All prices are f. o. b. Chicago unless otherwise stated. Owing to the unsettled market conditions governing high grade raw materials, all prices and quotations are subject to change without notice.

TERMS.

Accounts are payable thirty days from date of invoice. Those overdue are liable to sight draft. Parties unknown to us, unless satisfactorily rated by commercial agencies, should send references with first order.

REMITTANCES.

Remit by draft, money order, registered letter or express money order.

INDEX OF SYSTEMS

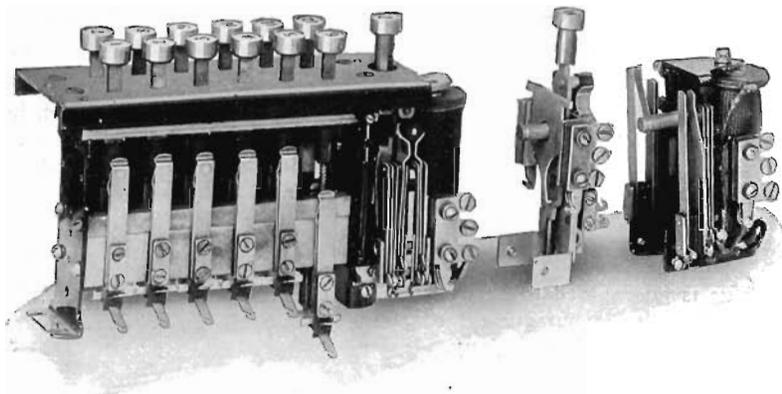

“KEY TO THE SYSTEM.”

For quick reference we give here fundamental features of standard Kellogg Automatic Interior Systems listed and described on the following pages. If your problem is not covered here, write us the details and we will give you a correct solution.

In all cases, furnish us with a rough pencil sketch of the relative location of your telephones and approximate distances between them. This will help both of us.

System No. 1.—Automatic Interior Secret Service, non-interfering, selective ringing and talking, full metallic, trunking or non-trunking, supervision by officials. **Page 8**

System No. 2.—Automatic Interior Non-Secret, non-interfering selective ringing and talking, full metallic or common return, trunking or non-trunking. **Page 8**

System No. 3.—Automatic Interior Secret Trunk, non-secret local, non-interfering, selective ringing and talking, full metallic, for service to City or Private Branch Exchange, manual or automatic. **Page 10**

System No. 4.—Automatic Interior Magneto, selective ringing and talking, non-interfering, adapted for use on long lines and for party line service to reduce cost of construction. **Page 12**

Call and Return System.—Description and illustration of our call and return desk and wall telephones. Circuit diagram is shown on page 25. **Page 15**

Trunking.—Description of the different trunking combinations for our standard systems when used in connection with common battery manual and other type exchanges, including magneto. Specify always the number of trunks you want. **Page 21**

Common Talking and Signaling.—Description of our common talking and common signaling system. Telephones illustrated on page 16. **Page 32**

Centerphone System.—Description of our common talking and signaling system from outlying stations to central station and selective signaling from central station to outlying stations. Telephones illustrated on page 16. **Page 33**

Common Talking Selective Signaling.—Description of our common talking selective signaling system between all telephones. Telephones illustrated on page 17. **Page 34**

KELLOGG SWITCHBOARD AND SUPPLY COMPANY, CHICAGO

GENERAL.

In this catalog we are describing the Kellogg Automatic Interior Telephones and Systems and we do not want you to confuse our equipment and systems with the ordinary Intercommunicating and Door Bell Systems.

The Kellogg Switchboard & Supply Co., being the largest Independent telephone manufacturer in the field, realized long ago the urgent need of a dependable Interior System of communication with the result that an Interior System far in advance of anything heretofore placed on the market, and consisting of correctly designed circuits and apparatus of the same grade and character as placed by us in some of the largest Independent exchanges in the United States, is now offered.

Kellogg talking sets are world famed for their ability to reproduce the human voice with a volume and clarity that makes conversation over the telephone a pleasure.

This transmission efficiency is recognized as a high standard and is meeting the demand of the most exacting users of telephones.

TWO CLASSIFICATIONS.

We are meeting the need of two separate and distinct classes of trade and we wish at this time to explain each so that you can determine for yourself under which classification you belong.

Kellogg telephones (over 3,000,000) and central office equipments are standard in a great many cities and towns throughout the world and the telephone companies in these places are, in a way, our representatives and are familiar with all of our products. You may be located in one of these places and being in need of an Interior Telephone System write us for prices and information. We want to feel free to refer your inquiry to our local representatives, knowing they will be of assistance in more ways than one. You may not care for any connection with this company's exchange but this need not keep you from looking to them for telephone information, and there will be no cost to you in any way for such information. In case you wish connection with the local exchange it will then be necessary to consult the local company.

The second classification includes all purchasers desiring to install an Interior System entirely separate from any local city telephone exchange and where we have no representative. To such purchasers we offer an unexcelled service from the engineering standpoint and assurance of our hearty co-operation at all times. For those in this classification, we present some terse facts under "Why You Should Have Our System" and we know you will be interested in some one of these facts, if not all.

Every individual in your employ has an earning power for your company which reaches its highest efficiency only when this individual's loss of time and action have been eliminated and converted into activity.

THE IDEAL.

If, as you sit at your desk mentally making note of the thoughts you wished to embody in a letter to Mr. Smith, your stenographer could mentally pick up these thoughts and write your letter there would be no loss of time in dictating and no loss of the actions necessary in taking the dictation.

Again, suppose you were wishing you had your company's last financial report to glance at and your auditor mentally picked up this thought and at once placed this report in your hands.

If action might thus be taken on all your mental activity governing your business, it would surely place you at your highest efficiency. Then suppose the heads of all your departments could do likewise. But, you say, this is only an ideal.

KELLOGG SWITCHBOARD AND SUPPLY COMPANY, CHICAGO

THE PRACTICAL.

Mankind has approached this ideal in the transmission of thought by the adoption and use of the telephone to convey these thoughts put into speech. Kellogg Automatic Interior Systems are eliminating in many institutions which have adopted them, the great losses due to old and obsolete methods of communication between departments and individuals. They are demonstrating new uses for the telephone in all departments of business, bringing these departments into closer relationship with no loss of time.

SOME FACTS.

Many times people outside your place of business calling for some of your departments receive the answer that the line is "busy." This is a very irritating report to most people and can be greatly reduced if you will install an Automatic Interior System.

Do not overlook this feature, as it is of more importance than the average person realizes.

"Talk, Don't Walk." The simplicity in operation, the speed and accuracy increases the telephone habit of your employees and saves much of their time. This saving amounts to a great deal in dollars and cents during the year.

In having your operator (if you have one) complete the telephone connections in your own establishment you are not relieving your telephone users of any appreciable work or loss of time, but rather are you consuming their time because this method is much slower than that of the Automatic Interior Telephone.

WHY YOU SHOULD HAVE OUR SYSTEM.

It requires no operator. It is on duty twenty-four hours a day, every day in the year, (vacations and all).

It never demands a raise in wages, pay for overtime, or special favors.

It makes no mistakes in numbers or names.

It does not grow tired or negligent of its duties.

It does not talk back but gives you instant service on the pressure of a button.

You can make a second call as readily as you made the first.

Probably more than seventy per cent (70%) of your telephone calls are within your own place of business; then place them under your own control.

Every telephone on the system may be in use and yet there would be no slowing up in service, no loss in efficiency.

It creates a telephone habit in your establishment and saves much time wasted in useless running about. "Talk, Don't Walk."

SPECIAL SIGNAL SYSTEMS.

In many places special signals for code calling and for conferences are desired and these can readily be arranged to work in connection with our regular Automatic Interior System. If your problem in this respect is submitted we will give you a correct solution.

KELLOGG SWITCHBOARD AND SUPPLY COMPANY, CHICAGO

INTERIOR TELEPHONES IN THE HOME.

There are relatively as many uses for Automatic Interior Telephones in the home as in the place of business and it is just as necessary to eliminate loss of time and action in the home as in business. Orders to the maid, the cook, the gardener, the chauffeur, the laundress, may be given with ease by means of the telephone. In the home where there are no servants, private telephones save many steps and much worry, and after being used a short time become a necessity.

AUTOMATIC SECRET SERVICE.

Many times it becomes necessary to have your telephone service secret so that others can not hear your conversation. We are in a position to furnish you this high class service at a nominal cost. The Automatic Secret Service Interior System is operated in practically the same manner as our regular Automatic Interior System and is the only system of its kind now on the market.

Officials in many places of business would appreciate being able to have this service between themselves and the heads of certain departments and at the same time be able to supervise the telephones not requiring this high-class service. Such a combination of service is easily given on our Automatic Secret System and we invite your inquiry relative to such problems.

EQUIPMENT.

Our equipment is the result of careful study and development by engineers who have had unlimited experience in the telephone field. It is of pleasing appearance, made of the best materials, and has satisfactorily stood the test of years of service.

Simplicity of installation and operation is the keynote of the system.

A compact encased moisture proof cable no larger than your little finger connects one telephone with another. No loose, dangling wires, which soon become unsightly, to contend with. When deciding on your system you fix what you think will be the ultimate number of telephones and your equipment and cable conforms to that decision. This is necessary in any telephone installation.

There are no delicate special tripping mechanisms on our telephones requiring frequent adjustments.

There is no complicated "Central" equipment in this system with a multiplicity of moving parts and intricate mechanisms requiring the attention of an expert. With the exception of the battery the equipment is all on your desk, or in a wall telephone, and is so simple that any electrician can care for it.

TO CALL—Just press a button. Could anything be more simple?

There is no extra weight or mechanism added to your telephone.

Kellogg Bakelite, a new and wonderful insulating material having a tensile strength of 4,800 pounds to the square inch and standing a temperature of 572° Fahrenheit, insoluble in all solvents, is used in the construction of all receiver shells, mouthpieces, etc., on our high grade telephones. Constant wear does not discolor this material and it will stand any amount of hard usage.

KELLOGG SWITCHBOARD AND SUPPLY COMPANY, CHICAGO

SYSTEM NO. 1.

AUTOMATIC SECRET INTERIOR SYSTEM.

FULL METALLIC.

Used where the highest class of service is required for Interior telephone service. It gives **Secret Service** on all conversations—is therefore non-interfering. As many conversations can be carried on at one time as there are pairs of telephones. A test button is provided which indicates whether or not the called telephone is busy. This adds one station to all outfits listed below. Each button has a number cap for designation purposes and the key box is equipped with name plates, one of which is associated with each key.

OPERATION.

TO ANSWER—Remove the receiver and talk. Operation in detail on page 21.

TO CALL—Press the button corresponding to the number of the telephone wanted, down as far as it will go, then press the test button to the same position. This operates the signal on the telephone called. If the called telephone is busy the test button cannot be pressed down. Restoring the receiver to the switch hook places lines and apparatus in a normal position.

SPECIAL—Combinations making it possible for officials to listen in and supervise other connections can be made. Code call signal system can be operated.

WIRING.

The wiring is for full metallic circuits and is carried in specially constructed moisture proof Kellogg cable listed on page 19.

The cable requires as many No. 22 B&S gauge twisted pairs as there are buttons on the key, plus one pair of No. 16 B&S gauge twisted pair for ringing battery.

CIRCUITS.

A circuit diagram of this system is shown on page 26, Number CA-11. Complete circuit diagrams are furnished with each order.

All talking circuits are perfectly balanced and free from cross talk, as battery is fed through balanced impedance coils.

TRUNKING—If your Interior System is to be connected to the City Telephone Exchange or to your own Private Branch Exchange board, refer to page 21 for complete information.

JUNCTION BLOCKS—For use with this system may be found on page 14.

BATTERY—A 20-volt talking battery, and a 9-volt ringing battery, are used with this system.

DESK TELEPHONE TYPE.

This is our desk type of Automatic Secret Interior Telephone. The stand is made so that all parts are readily accessible, the finish is of black enamel and nickel. The transmitter and receiver are of the same type as used on our standard long distance telephones. The key box is of metal finished in black enamel. This system is non-interfering, as any number of conversations can be carried on at the same time. The buzzer is mounted in the key box unit and requires no special wiring.



No. 8112D.

Code Number	Number of Buttons	Price
8108D	8	\$41.30
8112D	12	44.55
8116D	16	47.80
8120D	20	50.95
8124D	24	53.75

KELLOGG SWITCHBOARD AND SUPPLY COMPANY, CHICAGO

DESK GRABAPHONE TYPE.

This is the Kellogg desk type Grabaphone for Automatic Secret Interior Service, finished in black enamel and nickel, and having the high-grade equipment that marks all Kellogg products. Associated with it is our standard Secret Service key box with the exclusive Kellogg features. The buzzer is a part of this unit.



No. 8112DG.

Code Number	Number of Buttons	Price
8108DG	8	\$44.35
8112DG	12	47.60
8116DG	16	50.75
8120DG	20	54.05
8124DG	24	56.80

WALL GRABAPHONE TYPE.

This is our wall type Grabaphone set for use where regular wall or desk set is not desired. The key box may be mounted in any convenient location. The equipment is of the same standard as that used in the other outfits in this system. The service is Secret.



No. 8112WG

Code Number	Number of Buttons	Price
8108WG	8	\$45.00
8112WG	12	48.25
8116WG	16	51.45
8120WG	20	54.70
8124WG	24	57.45

WALL TELEPHONE TYPE.

This is our non-flush wall type Automatic Secret Interior Telephone. The box is made of metal, finished in black enamel and so arranged that when opened all parts are accessible. Our standard high-grade long distance transmitter and receiver are used in this set. It is non-interfering and as many conversations may be carried on at the same time as there are pairs of telephones. Double gong ringer is used for signaling.



No. 8112W.

Code Number	Number of Buttons	Price
8108W	8	\$38.55
8112W	12	41.70
8116W	16	45.00
8120W	20	48.25
8124W	24	51.00

EXAMPLE ORDER FOR SYSTEM NO. 1. CIRCUIT CA-11.

This selection is based on an installation of 10 stations and as a 12 station key is our next standard size, it will be figured for this system. (No Trunks.)

Code No.	No.	Description.		
8112D	5	Automatic Secret Service Desk Outfit @ \$44.55	\$222.75	
8112DG	3	Desk Type Grabaphone Outfit.....@ 47.60	142.80	
8112W	2	Non-Flush Wall Outfits.....@ 41.70	83.40	
8848	5	Universal Key Box Brackets.....@ 2.00	10.00	
10	3	Standard Sperry Brackets No. 2 Mtg. @ 5.00	15.00	
2513-B	10	Junction Blocks.....@ 3.15	31.50	
	25	Columbia Dry Batteries.....@ .59	14.75	
300 Ft.		12 Pair Leaded Cable.....@ Per 100 ft. 49.05	147.15	
				\$667.35

KELLOGG SWITCHBOARD AND SUPPLY COMPANY, CHICAGO

SYSTEM NO. 2.

AUTOMATIC NON-SECRET INTERIOR SYSTEM.

FULL METALLIC AND COMMON RETURN.

Used where a high class Interior telephone service is required. It is non-interfering and as many conversations can be carried on at one time as there are pairs of telephones. Each button is provided with a number cap for designations; a name plate is also associated with each key.

OPERATION.

TO ANSWER—Press "Home" button, which has a red designation. Operation in detail on page 22.

TO CALL—Press the button corresponding to the number of the telephone wanted, down as far as it will go. This operates the signal on the telephone called, and releasing the button allows it to return to the intermediate or talking position. When thru talking simply hang up receiver. The button locked down is automatically restored to normal position the instant another button is depressed.

WIRING.

The wiring is for full metallic or common return and is carried in a high grade moisture proof Kellogg cable listed on page 19.

The cable requires as many No. 22 B&S gauge twisted pairs for metallic (or single wires for common return) as there are buttons on the key, plus one pair No. 16 B&S gauge twisted pair for ringing battery.

CIRCUITS.

A metallic circuit diagram of this system is shown on page 27, Number CA-35. Complete circuit diagrams are furnished with each system. All talking circuits are perfectly balanced and free from cross talk, as battery is fed through special balanced impedance coils.

TRUNKING—If Interior System is to be connected to the City Telephone Exchange, or to your own Private Branch Exchange board, refer to page 22 for complete information on trunking.

JUNCTION BLOCKS—For use with this system are listed on page 14.

BATTERY—A 6-volt talking and a 6-volt ringing battery are used with this system for ordinary distances between telephones. Dry cells or storage batteries may be used.

DESK TELEPHONE TYPE.

This is our desk type Automatic Interior Telephone. The stand is made so that all parts are readily accessible. The finish is in black enamel and nickel, the transmitter and receiver are the same as used on our standard long distance telephones. The key box is of metal, finished in black enamel. It is non-interfering and as many conversations can be carried on at one time as there are pairs of telephones.



No. 8212D.

Code Number	Number of	Metallic	Common
Metallic	Buttons	Price	Return
			Price
8208D	8	\$28.85	\$27.50
8212D	12	32.20	29.95
8216D	16	35.35	32.45
8220D	20	38.55	34.95
8224D	24	41.70	37.45

LOGG SWITCHBOARD AND SUPPLY COMPANY, CHICAGO

DESK GRABAPHONE TYPE.

This is the Kellogg desk type Grabaphone for Automatic Interior Service, finished in black enamel and nickel, and having the high grade equipment that marks all Kellogg products. Associated with it is our standard key box with the exclusive Kellogg features. The buzzer is a part of this unit.



Code Number Metallic	Number of Buttons	Metallic Price	Common Return Price
8208DG	8	\$31.95	\$30.45
8212DG	12	35.10	32.95
8216DG	16	38.45	35.45
8220DG	20	41.60	37.95
8224DG	24	44.80	40.45

No. 8212DG.

WALL GRABAPHONE TYPE.

This is our wall type Grabaphone set for use where regular wall or desk set is not desired. The key box may be mounted in any convenient location. The equipment is of the same standard as that used in the other outfits in this system.



No. 8212WG.

Code Number Metallic	Number of Buttons	Metallic Price	Common Return Price
8208WG	8	\$32.60	\$31.20
8212WG	12	35.85	33.55
8216WG	16	39.05	36.05
8220WG	20	42.25	38.55
8224WG	24	45.50	41.10

WALL TELEPHONE TYPE.

This is our non-flush wall type of Automatic Interior telephone. The box is made of metal, finished in black enamel and so arranged that when open all parts are readily accessible. Our standard high grade long distance transmitter and receiver are used in this set. It is non-interfering.



No. 8212W.

Code Number Metallic	Number of Buttons	Metallic Price	Common Return Price
8208W	8	\$26.20	\$24.65
8212W	12	29.25	27.20
8216W	16	32.60	29.70
8220W	20	35.85	32.20
8224W	24	39.05	34.60

EXAMPLE ORDER FOR SYSTEM NO. 2—METALLIC.

CIRCUIT CA-35.

This selection is based on an installation of 22 stations and as a 24 station key is our next standard size, it will be figured for this system. (No Trunks.)

Code No.	No.	Description.		
8224D	10	Desk Telephone Outfits.....	@ \$41.70	\$ 417.00
8224DG	3	Desk Type Grabaphone Outfits.....	@ 44.80	134.40
8224W	9	Wall Telephone Outfits.....	@ 39.05	351.45
8848	5	Universal Mtg. Brackets.....	@ 2.00	10.00
2525-B	20	Junction Blocks	@ 5.25	105.00
10	5	Standard Sperry Brackets No. 2 Mtg.....		25.00
	16	Columbia Dry Batteries.....	@ .59	9.44
	700 Ft.	24 Pair Leaded Cable.....	@ per 100 ft. 72.50	507.50

\$1,559.79

KELLOGG SWITCHBOARD AND SUPPLY COMPANY, CHICAGO

SYSTEM NO. 3 AUTOMATIC SECRET TRUNK INTERIOR SYSTEM. FULL METALLIC.

Used where the Automatic Interior System is to work in connection with a common battery manual or automatic City Exchange or your own Private Branch Exchange. The trunk service is secret and the local service between stations is selective ringing and talking. On automatic exchanges this system prevents the breaking up of dialing when two people try to take the same trunk line.

OPERATION.

TO ANSWER—Press your "Home" button, which has a red designation, remove the receiver and talk. Operation in detail on page 23.

TO CALL LOCAL—Press the button corresponding to the number of the telephone wanted, down as far as it will go. This operates the signal on the telephone called, and releasing the button allows it to return to an intermediate or talking position.

TO CALL TRUNK—Remove the receiver and press down the trunk button. If the trunk is not in use give your number directly to the exchange operator, but if the trunk is busy the secret device on the key will lock you out. In case there is more than one trunk you try until you find one idle.

ATTENDANTS' SERVICE—Is described on page 24 under heading "Instructions For Operating Attendant Station."

WIRING.

The wiring is for full metallic and is carried in a high grade moisture proof Kellogg cable listed on page 19.

The cable requires as many No. 22 B&S gauge twisted pairs as there are buttons on the key, plus one pair No. 16 B&S gauge twisted pair battery wires and as many No. 22 B&S gauge single wires as there are trunks to be used.

CIRCUITS.

A circuit diagram of this system is shown on page 28, Number CA52.

Complete circuit diagrams are furnished with each order. All talking circuits are perfectly balanced and free from cross talk as battery is fed through balanced impedance coils.

JUNCTION BLOCKS—For use with this system are listed on page 14.

BATTERY—A 20 volt talking battery, and 9 volt ringing battery are used with this system for ordinary distances between telephones. Dry cells or storage battery may be used.



No. 8312D.

DESK TELEPHONE TYPE

This is our desk type Automatic Secret Trunk Interior Telephone. The stand is made so that all parts are readily accessible. The finish is in black enamel and nickel, transmission elements are standard. The key box containing the keys, buzzer and Secret magnet is finished in black enamel.

Code Number	Number of Buttons	Price
8308-D	8	\$37.60
8312-D	12	40.45
8316-D	16	43.70
8320-D	20	45.30
8324-D	24	50.05

KE' LOGG SWITCHBOARD AND SUPPLY COMPANY, CHICAGO

DESK GRABAPHONE TYPE.

This is the Kellogg desk type Grabaphone for Automatic Secret Trunk Service. It is finished in black enamel and nickel and has the high grade apparatus that marks all Kellogg Equipment. Associated with it is our standard Secret Trunk key box, having the exclusive Kellogg features.



No. 8312DG.

Code Number	Number of Buttons	Price
8308DG	8	\$40.70
8312DG	12	43.45
8316DG	16	46.70
8320DG	20	49.90
8324DG	24	53.10

WALL GRABAPHONE TYPE.

This is our wall type Grabaphone set, for use where regular wall set or desk set is not desired. The Secret Trunk key box may be mounted in any convenient location. The equipment is of the same standard as used in our other outfits.



No. 8312WG.

Code Number	Number of Buttons	Price
8308WG	8	\$41.30
8312WG	12	44.10
8316WG	16	47.30
8320WG	20	50.50
8324WG	24	53.75

WALL TELEPHONE TYPE.

This is our non-flush wall type of Automatic Secret Trunk Interior Telephone. The box is made of metal, finished in black enamel and so arranged that when open all parts are accessible. Our standard high grade long distance transmitter and receiver are used in this set.



No. 8312W.

Code Number	Number of Buttons	Price
8308W	8	\$34.95
8312W	12	37.60
8316W	16	40.85
8320W	20	44.10
8324W	24	47.35

EXAMPLE ORDER FOR SYSTEM NO. 3.

CIRCUIT CA52.

This selection is based on an installation of 6 stations and 1 trunk which will take our standard 8 button key providing growth for either 1 more local telephone or 1 trunk line.

Code Number	Description	Price
8308D	Desk Telephone Outfits.....@ \$37.60	\$188.00
8308DG	Desk Type Grabaphone Outfits.....@ 40.70	122.10
8742D	Trunk Cabinet 1 Trunk Equipped.....@ 29.60	29.60
8848	Universal Key Box Mtg. Bracket.....@ 2.00	12.00
2509-B	Junction Blocks@ 2.50	20.00
10	Standard Sperry Brackets No. 5 Mtgs@ 5.00	15.00
250 ft.	8 Pair Leaded Cable.....@ per 100 ft. 38.00	95.00
		\$481.70

KELLOGG SWITCHBOARD AND SUPPLY COMPANY, CHICAGO

SYSTEM NO. 4.

AUTOMATIC MAGNETO INTERIOR SYSTEM. FULL METALLIC.

There are many instances where the distances between telephones are too great to give good service from a central talking and ringing battery, and in such cases our Magneto Interior System will give the service desired in a very satisfactory way. The equipment is a combination of our standard magneto telephones with our regular Interior type key boxes, and the different combinations are explained below. Many classes of service may be secured from this system so do not hesitate to submit to us your problem.

OPERATION.

TO ANSWER—Press "Home" button, which has a red designation, remove your receiver and talk.

TO CALL—Press the button on the key box corresponding to the number of the telephone wanted, operate your generator by means of the crank, and this will ring the bell on the telephone being called, remove the receiver and talk. To ring a second time, in case party has not answered, hold receiver hook down and operate the generator again. Operation in detail on page 24.

TO CALL TRUNK—In calling the exchange, the method of operation just described is used.

WIRING.

The wiring is for full metallic and may be carried in Kellogg special moisture proof cable, or if the distance is great, paper core, lead-incased cable may be used. It is also possible to use ordinary open wire construction work. There will be as many pairs of wire required as there are keys on your key box or as the ultimate number of telephones to be installed.

CIRCUITS.

A circuit diagram of this system is shown on page 29, Number CA-60. Complete diagrams are furnished with each order. This system, when installed, will be free from all cross-talk.

TRUNKING—If your Interior System is to connect to the City Telephone Exchange, or to your own Private Branch Exchange board, refer to page 24 for complete information on trunking.

JUNCTION BLOCKS—In making connections from the key to the main cable, it is best to use a junction block, and these are illustrated on page 14.



No. 8412D

DESK TELEPHONE TYPE.

This is our magneto desk outfit for Automatic Interior Service, and includes our standard local battery desk stand, a generator and ringer in our standard box and our standard Automatic key box. The desk stand is finished in black enamel and nickel, the key box in black enamel and the bell and generator box in golden oak.

Code Number	Number of Buttons	Price
8408D	8	\$40.25
8412D	12	43.55
8416D	16	46.95
8420D	20	50.25
8424D	24	53.50

KELLOGG SWITCHBOARD AND SUPPLY COMPANY, CHICAGO

DESK GRABAPHONE TYPE.

This is the Kellogg desk type Grabaphone for Magneto Interior Service. It is finished in black enamel and nickel and has the high grade equipment that marks all Kellogg products. Associated with it is our standard Automatic Interior key box and our generator box, which may be mounted in a convenient place.

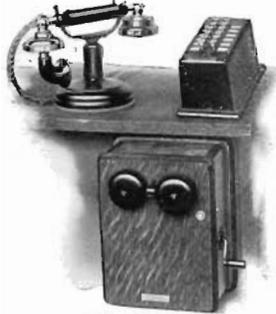

No. 8412DG

Code Number	Number of Buttons	Price
8408DG	8	\$44.20
8412DG	12	47.50
8416DG	16	50.95
8420DG	20	54.20
8424DG	24	57.45

WALL GRABAPHONE TYPE.

This is our wall type Grabaphone set, for use where a wall telephone or desk set is not desired. The key box may be mounted in any convenient location. The equipment is of the same standard as used in our other outfits.



No. 8412WG

Code Number	Number of Buttons	Price
8408WG	8	\$39.20
8412WG	12	42.55
8416WG	16	45.95
8420WG	20	49.20
8424WG	24	52.50

WALL TELEPHONE TYPE.

For our wall type Interior magneto sets, we use our standard compact magneto wall telephone, having associated with it an Automatic Interior type key box. This is a bridging telephone, having a three-bar generator and 1000-ohm ringer.



No. 8412W

Code Number	Number of Buttons	Price
8408W	8	\$38.85
8412W	12	42.20
8416W	16	45.60
8420W	20	48.85
8424W	24	52.00

**EXAMPLE ORDER FOR SYSTEM NO. 4.
CIRCUIT CA60.**

This selection is based on an installation of 9 stations and we therefore will figure our 12 button outfit.

Code No.	No.	Description	Price
8412D	2	Desk Telephone Outfits.....@	\$43.55
8412W	7	Wall Telephone Outfits.....@	42.20
8848-A	1	Universal Key Box Mtg. Bracket.....@	2.00
2513-B	7	Junction Blocks	@ 3.15
	750 ft.	12 Pair Leaded Cable.....@ per 100 ft.	49.05
			370.87
			\$777.42

Other construction material will depend on conditions.

ACCESSORIES.

KEY BOX BRACKET.



This shows the use of our Universal Bracket for mounting the Automatic Interior desk set key box. This bracket may be mounted on the right or left hand side of either roll top or flat top desk and turned so that the key box is in the most convenient position. Its use assures a neat installation.

Code Number	Price
8848	\$2.00

JUNCTION BLOCK.

This is our latest junction block, arranged for both solder and screw connections. On each clip there is provided one screw and two soldered connections. A fibre fanning strip is provided and so arranged that it is not necessary to form and lace the cables, which may enter the box from either end. This is the most flexible high class terminal we make for all work where junction boxes and branch terminals are required. The cover is of metal thoroughly enameled and attached to the block with two screws.

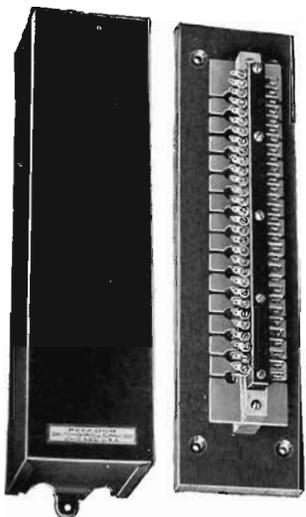

Code Number	No. of Pairs	Price
2505-B	5-pair	\$1.40
2509-B	9-pair	2.50
2513-B	13-pair	3.15
2517-B	17-pair	3.95
2521-B	21-pair	4.55
2525-B	25-pair	5.25

TERMINAL STRIP.

We show here a lock nut terminal strip to be used where heavy wires are used and where no soldered connections are to be made. Sizes ranging from 1 to 26 pairs can be furnished.



Code Number	Price
8000	Per Pair \$0.29

EXTENSION BELL.

This is our direct current double gong extension bell to be used as an extension signal for desk outfits which have a buzzer as a standard signal. Golden Oak is standard finish, but other finishes will be furnished at an extra cost of 50 cents each net.

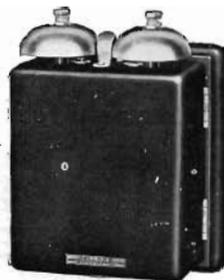

Code Number	Price
8229	\$3.75

ACCESSORIES—Continued.

IMPEDANCE COIL.



The impedance coil shown here is of the highest efficiency, having a special iron core and a very heavy selected Norway iron shell with closed magnetic circuits at the ends. Standard wound coils are listed here but other windings can be furnished on request.

Code Number	Resistance	Price
8260-A	50 ohms	\$1.40
8260-B	100 ohms	1.40

ATTENDANT'S STATION.



This is our standard attendant's station for use on systems trunking to an exchange and using an attendant for receiving incoming calls. All outfits are wired for an ultimate of three trunks and equipped with the number specified in order. There is a drop for call signal to indicate on which line a call is being made and also a visual hold signal to indicate to the attendant when a trunk has been taken by a local party. Associated with each trunk is a double throw non-locking key for setting and releasing the hold signal. A night alarm circuit and switching key is provided. There are terminals in the box for terminating the taps from the trunk lines at the station where this outfit is located. Standard finish is golden oak but other finishes may be had for \$1.50 net additional.

ATTENDANT'S OUTFIT FOR SYSTEMS NO. 1, NO. 2, NO. 3.

Code Number	No. Trunks	Circuit	Price
8742-D	1	CA-70	\$29.60
8742-E	2	CA-70	43.75
8742-F	3	CA-70	57.85

CALL AND RETURN TELEPHONES.

WALL TYPE.



This is our black enameled metal wall set for call and return service. Two of these sets may be used or this set with our Code No. 8671 desk set may be used. Furnished with our direct current receiver, double gong ringer, and one push button. Suitable for use between two offices, house and garage, bedroom and kitchen, etc. Circuit CA66 shown on page 25.

Code Number	Price
8189 Wall set with one push button.....	\$8.80

DESK TYPE.

This is our high grade desk stand for call and return service. Two of these sets may be used or this set with a Code No. 8189 wall set may be used. The stand is finished in black enamel and nickel, has our direct current receiver, push button and bell as shown. Buzzer instead of bell will be furnished at the same price. Suitable for use between any two places within reasonable distance as two offices, house and garage, bedroom and kitchen. Circuit No. CA66 shown on page 25.

Code Number	Price
8671 Desk stand, connecting rack, cord and buzzer, one button	\$16.55



COMMON TALKING TELEPHONES.

WALL TYPE.



This is our black enameled steel wall set for common talking and selective signaling. The box is finished in durable black enamel. Our efficient direct current receiver is furnished on this set and any number of stations up to six equipped. For use on systems CA-3, CA-4 and CA-7, described on pages 32, 33 and 34. In ordering specify number of buttons.

Code Number	Price
8194 Wall set with one push button.....	\$8.80
Each additional button.....	1.25

DESK TYPE.



This is our desk stand for common talking and selective signaling, arranged for any number of stations from one to six. This set may be used with our wall set Code No. 8194. The stand is finished in black enamel and nickel, has direct current receiver, push buttons in base, buzzer and connecting rack mounted together. For use on systems, CA-3, CA-4 and CA-7 described on pages 32, 33 and 34. In ordering specify number of buttons.

Code Number	Price
8672 Desk stand, one push button, connecting rack and buzzer	\$16.55
Each additional button with cord and connecting rack terminal	1.35

RETARDATION COIL.



This is our retardation coil which is used on all common talking systems to prevent inductive disturbances and increase the talking efficiency. Only one coil required for each system.

Code Number	Price
16C 4½ ohms	\$0.65

KELLOGG
"GRABAPHONE AND TALK RIGHT."



Have you ever reached for your desk telephone, and on attempting to bring it to a convenient talking position, found the cord wound around the ink stand, under the letter basket or tied into knots until it is so short you can not get close enough to the transmitter? Disaster and destruction are the results. We know just how you would like to express your thoughts and how you wish some one had intelligence enough to invent something to get away from such trouble.

The Kellogg Switchboard & Supply Co., having for some time realized your need, has developed a practical and efficient Grabaphone which is going to change this and make it a pleasure for you to use the telephone. Kellogg Bakelite ear cap and mouthpiece help to make this set indestructible. Only one hand necessary to use the Kellogg Grabaphone, the transmitter is always just where it should be, insuring the greatest efficiency in transmission, and it makes no difference whether you are in a standing, sitting or reclining position. Below we show and give prices and description of Kellogg Grabaphone sets.

UNIT TYPE GRABAPHONE.



This is our No. 110A unit type stand and 11C Grabaphone for use on common battery exchange lines. This set has a 1000 ohm ringer with 2 M. F. condenser and does away with the usual desk set bell box. Base is of heavy pressed steel with Kellogg, durable enamel finish.

Code Number	Price
110AG	\$25.00

EXTENSION GRABAPHONE SET.



This is the Kellogg Grabaphone Extension Set combining a 12C Grabaphone with steel box containing switchhook, impedance coil and condenser. Can be mounted on the end or on the inside and below the top of a desk where it is easily reached.

Code Number	Price
722G	\$16.10

STANDARD DESK GRABAPHONE.



This is the Kellogg Grabaphone desk stand having a complete standard talking equipment. It can be used as an extension talking set without ringers but any standard ringer may be associated with it. The finish is in Kellogg durable black enamel.

Code Number	Price
111 Stand with 11C Grabaphone.....	\$16.20



Sperry Standard Bracket

THE SPERRY STANDARD BRACKET.

The Standard Bracket works horizontally only. It is of strong and durable construction. The lazy-tongs are made of $\frac{3}{4} \times \frac{1}{8}$ -in. steel. The closing of the bracket is provided for by posts made of $\frac{1}{2}$ -in. screw-steel telescoping into steel tubes. It is absolutely locked when fully extended and does not sag. Furnished complete with the minute clamp, any mounting selected, dummy hook, cord holders, and screws for mounting. Black enamel, standard finish.

THE SPERRY UNIVERSAL BRACKET.

The Sperry Universal Bracket is of the same rigid construction as the standard, with the added convenience of a vertical movement. It is held in any position desired, no matter how far extended or raised.

MOUNTINGS.

No. 1 is used on side of flat or roll top desk. No. 2 is used on the top of the desk. No. 3 clamps on edge of a flat top desk. No. 4 is used on a wall or partition. No. 5 is used on side of flat top desk. No. 6 is used on side of roll top desk. No. 7 is used on side of flat top desk. No. 9 attachment fits any mounting and holds two arms.

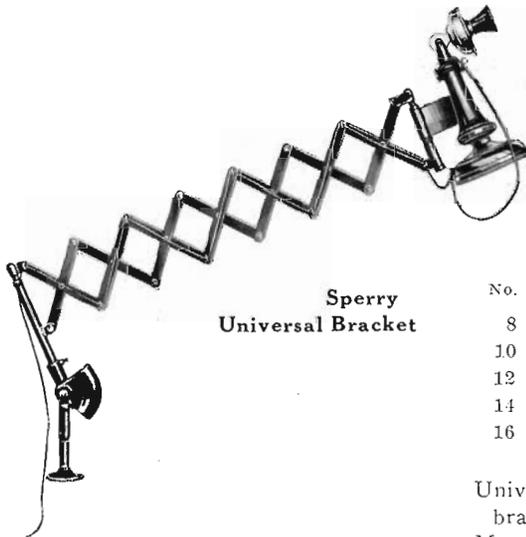

Sperry Universal Bracket

CLAMPS.

No. 20 Clamp fits all phones with a cylindrical barrel. No. 21 Clamp fits all phones with a convex shaped barrel.

PRICE LIST.

No.	Length extended	Styles and Prices			DeLuxe Universal
		Standard	Universal	DeLuxe	
8	26 in.	\$4.40	\$5.60	\$ 7.50	\$ 9.35
10	30 in.	5.00	6.25	9.35	10.00
12	34 in.	5.60	6.85	10.00	11.25
14	38 in.	6.25	7.50	11.25	12.50
16	42 in.	6.85	8.15	12.50	13.75

Universal attachment, when ordered without bracket	\$1.85
Mountings, each, except No. 3.....	.65
No. 3 mounting.....	1.05

On all orders where No. 3 mounting is substituted for any other mounting, add 35c to list.

Receiver hook, each.....	\$0.30
Minute clamp, complete.....	1.25
Minute holder only, each.....	.85
Minute clamps only, per pair.....	.45
Improved cord holders, per dozen.....	.30

Various Mountings for use with all Sperry Brackets

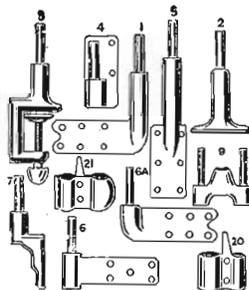

KELLOGG SWITCHBOARD AND SUPPLY COMPANY, CHICAGO

KELLOGG CABLE FOR AUTOMATIC INTERIOR SYSTEMS.

GENERAL.

It is essential that the cable used in the installation of Automatic Interior Systems be properly constructed to meet the various needs in the different places where cable is run.

Kellogg cable is being manufactured with the idea of making every installation as nearly perfect as possible and this means a moisture proof core properly wrapped and covered with a sheath of lead to make it further moisture proof as well as protect it from mechanical injury.

All line wires are of No. 22 B. & S. gauge tinned copper wire insulated with transverse wrappings of silk and cotton and arranged with a color scheme for proper identification in forming. In full metallic systems the paired wires are twisted together to prevent all inductive disturbances. A twisted pair of ringing battery wires of No. 16 B. & S. gauge tinned copper insulated same as line wires is provided in each cable. All wires are formed spirally into a cable and the whole covered with wrappings of paper over which is a braiding. The whole is then made moisture proof by boiling in beeswax after which a lead sheath is put on.

We make also a braided cable constructed in the same way as lead covered cable except that instead of a lead sheath we put on a heavy cotton braid which is given a coating of special fire proof paint.

In placing your order for cable be sure to give the number of pairs, also specify whether lead sheath or fireproof painted braid is wanted.

CABLE FOR INTERIOR SYSTEMS

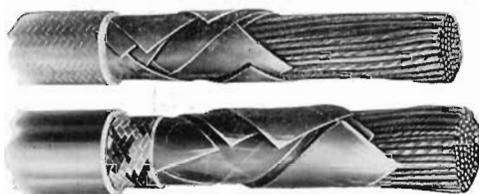

Description			Fire Proof Painted Braid Price	$\frac{1}{16}$ " Lead Sheath Price
8 Pr. No. 22 B. & S.	1 Pr. No. 16 B. & S.	1 Pr. No. 22 B. & S. spare.....	\$23.20	\$38.00
12 Pr. No. 22 B. & S.	1 Pr. No. 16 B. & S.	1 Pr. No. 22 B. & S. spare.....	30.70	49.05
16 Pr. No. 22 B. & S.	1 Pr. No. 16 B. & S.	1 Pr. No. 22 B. & S. spare.....	38.35	58.45
20 Pr. No. 22 B. & S.	1 Pr. No. 16 B. & S.	1 Pr. No. 22 B. & S. spare.....	45.95	63.70
24 Pr. No. 22 B. & S.	1 Pr. No. 16 B. & S.	1 Pr. No. 22 B. & S. spare.....	53.75	72.50
For Common Return				$\frac{1}{16}$ " Lead Sheath
8 Conductor No. 22 B. & S.	1 Pr. No. 16 B. & S.	1 Conductor No. 22 B. & S. spare.....	\$25.80	
12 Conductor No. 22 B. & S.	1 Pr. No. 16 B. & S.	1 Conductor No. 22 B. & S. spare.....	29.45	
16 Conductor No. 22 B. & S.	1 Pr. No. 16 B. & S.	1 Conductor No. 22 B. & S. spare.....	34.75	
20 Conductor No. 22 B. & S.	1 Pr. No. 16 B. & S.	1 Conductor No. 22 B. & S. spare.....	39.05	
24 Conductor No. 22 B. & S.	1 Pr. No. 16 B. & S.	1 Conductor No. 22 B. & S. spare.....	41.00	

BATTERY BOXES

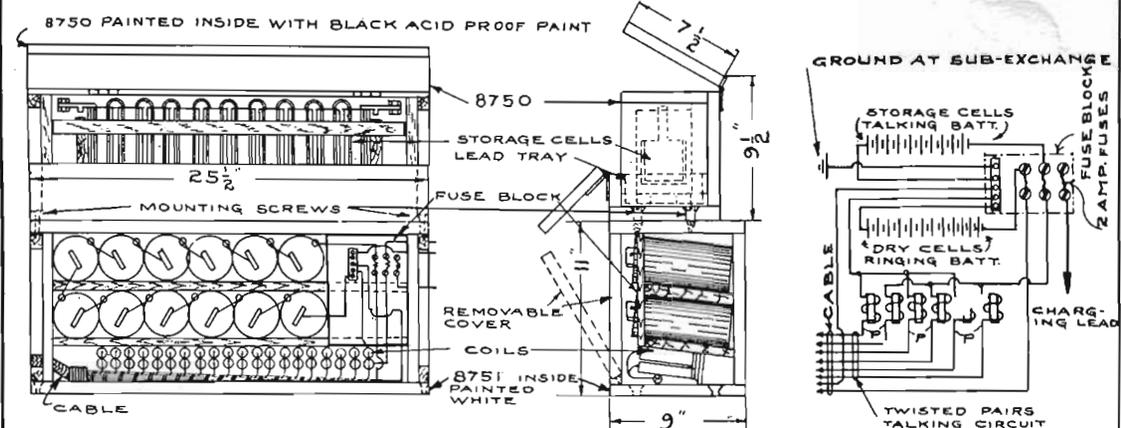

USED WITH SYSTEMS OPERATING IN CONNECTION WITH COMMON BATTERY EXCHANGES. OUTSIDE CHESTNUT, NATURAL FINISH. 8750 AND 8751 ARE BUILT IN SEPARATE UNITS. FIGURES 8750 AND 8751

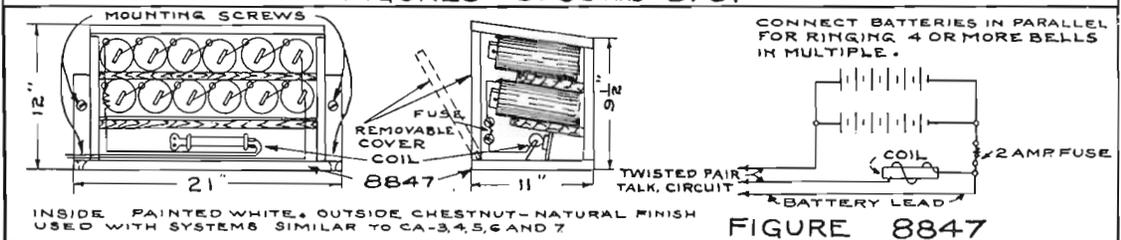

INSIDE PAINTED WHITE. OUTSIDE CHESTNUT-NATURAL FINISH. USED WITH SYSTEMS SIMILAR TO CA-3,4,5,6 AND 7. FIGURE 8847

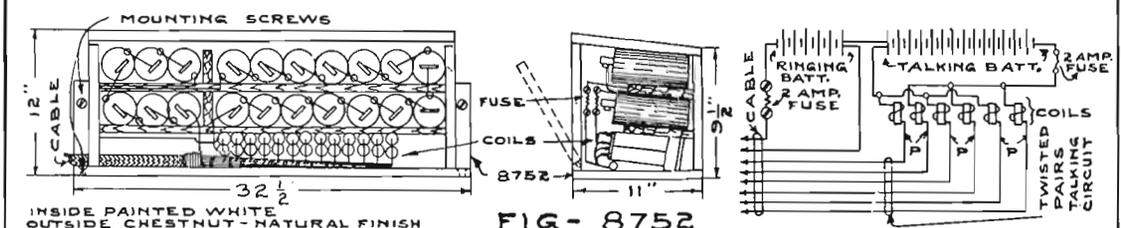

INSIDE PAINTED WHITE. OUTSIDE CHESTNUT-NATURAL FINISH. FIG- 8752

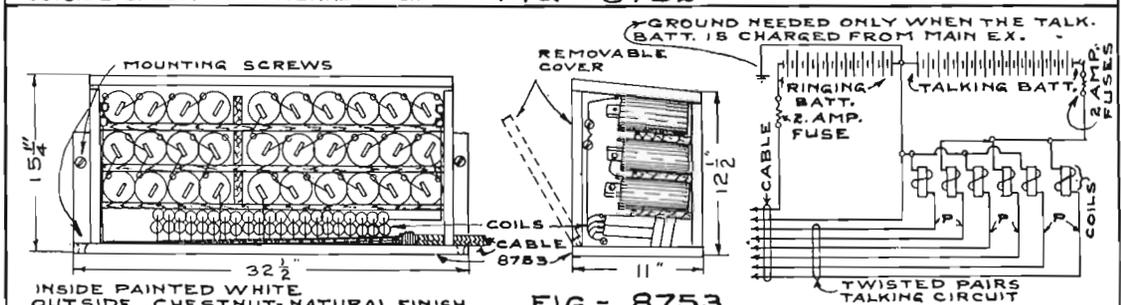

INSIDE PAINTED WHITE. OUTSIDE CHESTNUT-NATURAL FINISH. FIG.- 8753

NOTE:—AMPLE SPACE IS PROVIDED IN THESE BOXES FOR DISTRIBUTING THE CABLE FROM EITHER END OR THROUGH THE BOTTOM OF THE BOX. COILS AND BATTERIES NOT FURNISHED WITH BATTERY BOXES. INSTALL BATTERY BOXES IN A DRY PLACE. DRY BATT. INSTALLED AT PLACES WHERE INSPECTION CAN ONLY BE MADE AT CERTAIN INTERVALS AND CONSIDERABLE EXPENSE CELLS MAY BE PACKED IN DRY SAWDUST TO REDUCE EVAPORATION AND THEREBY INCREASE THE LIFE OF THE CELLS

CODE NO.	NO. & VOLT. OF CELLS TALKING	NO. & VOLT. OF CELLS RINGING	CELL CAPACITY OF BOX	PRICE	REMARKS	CODE NO.	NO. & VOLT. OF CELLS TALKING	NO. & VOLT. OF CELLS RINGING	CELL CAPACITY OF BOX	PRICE	REMARKS			
8847	6	9	12	\$5.00	SEE NOTE "A"	8752	14	20	6	9	20	\$7.50	NO. OF CELLS IN TALK. BATT. VARY	
8751		12	18	12	\$7.50	RING. BATT.	8753	18	27	12	18	30	\$7.50	NO. OF CELLS IN TALK. BATT. VARY
8750	10	STORAGE CELLS		10.00	TALK. BATT.								NOTE "A" SAME BATT. USED FOR RING. AND TALK.	

KELLOGG SWITCHBOARD AND SUPPLY COMPANY, CHICAGO

KELLOGG CABLE FOR AUTOMATIC INTERIOR SYSTEMS.

GENERAL.

It is essential that the cable used in the installation of Automatic Interior Systems be properly constructed to meet the various needs in the different places where cable is run.

Kellogg cable is being manufactured with the idea of making every installation as nearly perfect as possible and this means a moisture proof core properly wrapped and covered with a sheath of lead to make it further moisture proof as well as protect it from mechanical injury.

All line wires are of No. 22 B. & S. gauge tinned copper wire insulated with transverse wrappings of silk and cotton and arranged with a color scheme for proper identification in forming. In full metallic systems the paired wires are twisted together to prevent all inductive disturbances. A twisted pair of ringing battery wires of No. 16 B. & S. gauge tinned copper insulated same as line wires is provided in each cable. All wires are formed spirally into a cable and the whole covered with wrappings of paper over which is a braiding. The whole is then made moisture proof by boiling in beeswax after which a lead sheath is put on.

We make also a braided cable constructed in the same way as lead covered cable except that instead of a lead sheath we put on a heavy cotton braid which is given a coating of special fire proof paint.

In placing your order for cable be sure to give the number of pairs, also specify whether lead sheath or fireproof painted braid is wanted.

CABLE FOR INTERIOR SYSTEMS

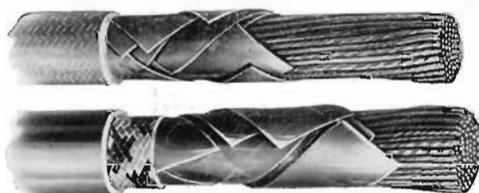

Description			Fire Proof Painted Braid Price	$\frac{1}{8}$ " Lead Sheath Price
8 Pr. No. 22 B. & S.	1 Pr. No. 16 B. & S.	1 Pr. No. 22 B. & S. spare.....	\$23.20	\$38.00
12 Pr. No. 22 B. & S.	1 Pr. No. 16 B. & S.	1 Pr. No. 22 B. & S. spare.....	30.70	49.05
16 Pr. No. 22 B. & S.	1 Pr. No. 16 B. & S.	1 Pr. No. 22 B. & S. spare.....	38.35	58.45
20 Pr. No. 22 B. & S.	1 Pr. No. 16 B. & S.	1 Pr. No. 22 B. & S. spare.....	45.95	63.70
24 Pr. No. 22 B. & S.	1 Pr. No. 16 B. & S.	1 Pr. No. 22 B. & S. spare.....	53.75	72.50
For Common Return				
8 Conductor No. 22 B. & S.	1 Pr. No. 16 B. & S.	1 Conductor No. 22 B. & S. spare.....	\$25.80	$\frac{1}{8}$ " Lead Sheath \$25.80
12 Conductor No. 22 B. & S.	1 Pr. No. 16 B. & S.	1 Conductor No. 22 B. & S. spare.....	29.45	29.45
16 Conductor No. 22 B. & S.	1 Pr. No. 16 B. & S.	1 Conductor No. 22 B. & S. spare.....	34.75	34.75
20 Conductor No. 22 B. & S.	1 Pr. No. 16 B. & S.	1 Conductor No. 22 B. & S. spare.....	39.05	39.05
24 Conductor No. 22 B. & S.	1 Pr. No. 16 B. & S.	1 Conductor No. 22 B. & S. spare.....	41.00	41.00

BATTERY BOXES

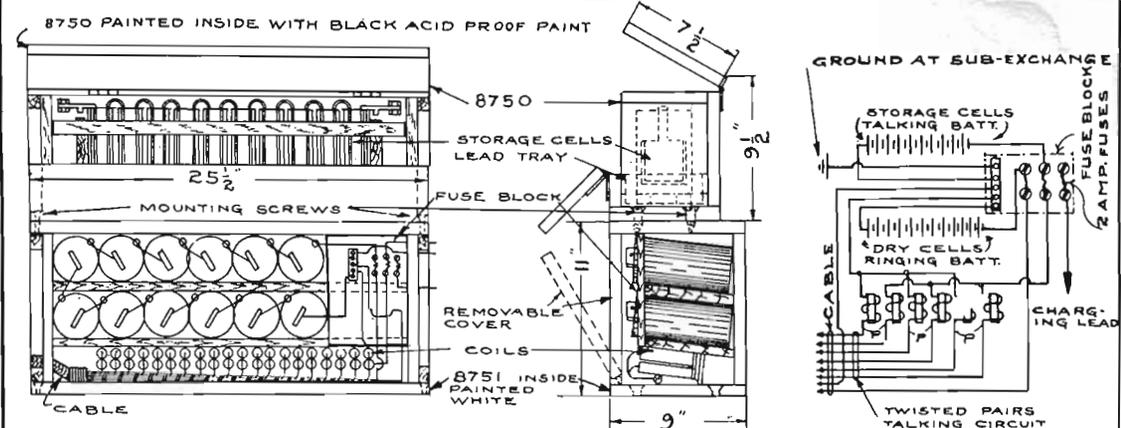

USED WITH SYSTEMS OPERATING IN CONNECTION WITH COMMON BATTERY EXCHANGES
 OUTSIDE CHESTNUT, NATURAL FINISH. 8750 AND 8751 ARE BUILT IN SEPARATE UNITS.
FIGURES 8750 AND 8751

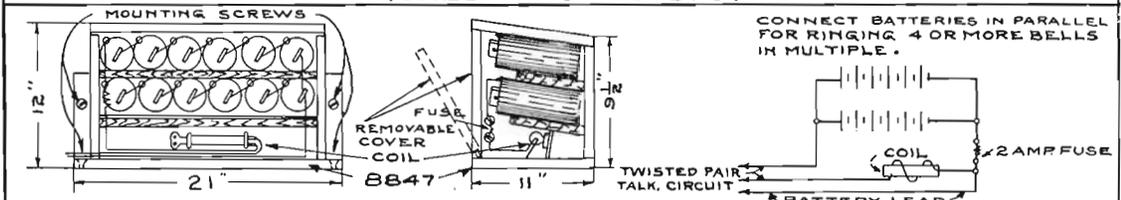

INSIDE PAINTED WHITE. OUTSIDE CHESTNUT-NATURAL FINISH
 USED WITH SYSTEMS SIMILAR TO CA-3,4,5,6 AND 7
FIGURE 8847

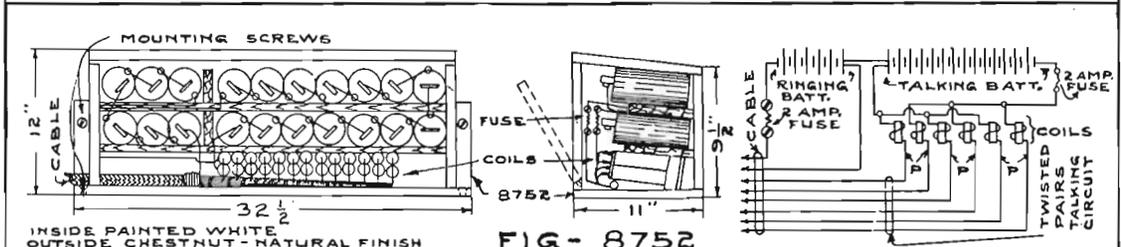

INSIDE PAINTED WHITE
 OUTSIDE CHESTNUT-NATURAL FINISH
FIG- 8752

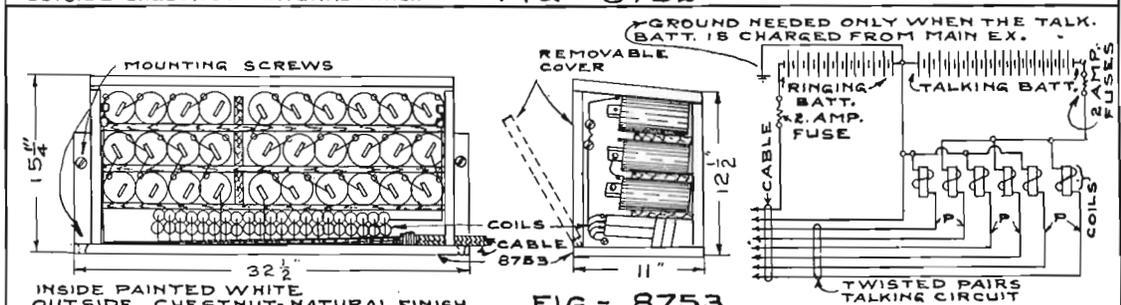

INSIDE PAINTED WHITE
 OUTSIDE CHESTNUT-NATURAL FINISH
FIG.- 8753

NOTE:-
 AMPLE SPACE IS PROVIDED IN THESE BOXES FOR DISTRIBUTING THE CABLE FROM EITHER END OR THROUGH THE BOTTOM OF THE BOX.
 COILS AND BATTERIES NOT FURNISHED WITH BATTERY BOXES.
 INSTALL BATTERY BOXES IN A DRY PLACE. DRY BATT. INSTALLED AT PLACES WHERE INSPECTION CAN ONLY BE MADE AT CERTAIN INTERVALS AND CONSIDERABLE EXPENSE CELLS MAY BE PACKED IN DRY SAWDUST TO REDUCE EVAPORATION AND THEREBY INCREASE THE LIFE OF THE CELLS

CODE NO.	NO. & VOLT. OF CELLS TALKING	NO. & VOLT. OF CELLS RINGING	CELL CAPACITY OF BOX	PRICE	REMARKS	CODE NO.	NO. & VOLT. OF CELLS TALKING	NO. & VOLT. OF CELLS RINGING	CELL CAPACITY OF BOX	PRICE	REMARKS			
8847	6	9	12	\$5.00	SEE NOTE "A"	8752	14	20	6	20	\$7.50	NO. OF CELLS IN TALK. BATT. VARY		
8751		12	18	12	\$7.50	RING. BATT.	8753	18	27	12	18	30	\$7.50	NO. OF CELLS IN TALK. BATT. VARY
8750	10 STORAGE CELLS			10.00	TALK. BATT.	NOTE "A" SAME BATT. USED FOR RING. AND TALK.								

TRUNKING SERVICE.

INSTRUCTIONS FOR OPERATION.—GENERAL.

Telephone companies purchasing Automatic Interior Systems for their subscribers will want complete trunking facilities, also large institutions now operating their own Private Branch Exchange may want to connect an Automatic Interior System to their board. The information given here is relative to such connections.

Trunking connections used may be classed under three general headings, namely: connections to common battery manual switchboards, to automatic switchboards and to magneto switchboards. The method of operation and equipment for the first two systems are the same but for the magneto there is a difference.

In ordering systems for trunking always specify the number of buttons to be arranged for trunking as the spring group and designation on these are different. If you purchase a twelve station outfit ten buttons may be for local service and two for trunks. Any regular button may be used for a trunk but we usually use the last buttons on a key, equipping them with trunk spring groups and designations.

SYSTEM NO. 1.

INSTRUCTIONS FOR OPERATING LOCAL SERVICE.

1. **TO CALL LOCAL PARTY**—Remove the receiver, and the home line will be made busy. Fully depress the selecting button on the line wanted, then release this button and fully depress the test button and the selected line will be made busy and the signal operated at the called station. If the called line is busy the test button cannot be depressed. The called party removes the receiver and talks.

2. **TO CALL AN EXCHANGE PARTY DIRECT**—Remove the receiver and the home line will be made busy. Fully depress one of the selecting trunk buttons and try the test button until an idle trunk line is found, then depress the test button to an intermediate position, which makes this trunk line busy, and connects your telephone to the trunk after which call is completed in the usual way.

3. **TO CALL AN EXCHANGE PARTY BY WAY OF THE ATTENDANT**—Remove the receiver and the home line is made busy. Fully depress the attendant's selecting button, then depress the test button which signals the attendant and makes that line busy. When the attendant answers advise the exchange party wanted, then hang up the receiver, this restores apparatus to normal. The attendant obtains the desired exchange party as described in paragraph 8, calls the local party instructing which trunk to take for exchange party. The local party presses the designated trunk button, then the test button to an intermediate position which connects the telephone to the designated trunk line and makes that line busy, restores the visual hold signal on the attendant's station to normal, and thus indicates to the attendant that the local party has answered on the designated trunk line. When through talking, place the receiver on the hook and all apparatus is restored to normal.

4. **TO ANSWER LOCAL PARTY**—Remove the receiver and talk. When through talking place the receiver upon the switch hook; this restores all apparatus to normal.

5. **TO ANSWER ATTENDANT'S TRUNK CALL**—Fully depress the designated trunk button, then depress the test button to an intermediate position, which connects your telephone to the designated trunk line and makes the line busy, and also restores the visual hold signal to normal and thus indicates to the attendant that the local party has answered on the designated trunk line. When through talking, place the receiver on the switch hook and all apparatus at your station and on the trunk line will be restored to normal.

KELLOGG SWITCHBOARD AND SUPPLY COMPANY, CHICAGO

SYSTEM NO. 1—Continued

1. INSTRUCTIONS FOR OPERATING ATTENDANT'S STATION.

6. TO CALL LOCAL PARTY—See "Instructions for Operating Local Stations," paragraph 1.

7. TO CALL AN EXCHANGE PARTY—See "Instructions for Operating Local Stations," paragraph 2.

8. TO CALL AN EXCHANGE PARTY FOR A LOCAL PARTY—The attendant learns the number of the exchange party wanted, fully depresses one of the selecting trunk buttons and tries the test button until an idle trunk line is found, then depresses this test button to an intermediate position which connects the telephone to the trunk line and makes the trunk busy. The exchange party is then obtained in the regular way and is requested to wait while the attendant moves the lever of the individual key, associated with this trunk, downward until the visual hold signal operates and the test button restores to normal, then releases this key and calls the local party in the usual manner, designates the trunk and places the receiver on the switch hook, which restores all the apparatus at the attendant's station to normal, except the visual hold signal on the designated line. The local party answering restores the attendant station to normal except the visual hold signal on the designated line. The local party answers the attendant's trunk call as described in paragraph 5.

9. TO ANSWER LOCAL PARTY—Remove the receiver and talk. When through talking place the receiver on the switch hook, which restores all apparatus at the station to normal.

10. TO ANSWER EXCHANGE PARTY—The attendant removes the receiver, and the attendant's line is made busy. The attendant then fully depresses the selecting button on the calling trunk line, then depresses the test button to an intermediate position, which connects the attendant's telephone to the trunk line and also makes the trunk line busy. Another party in the local system being wanted, the trunk party is requested to wait, and the attendant moves the lever of the individual key associated with this trunk line downward until the visual hold signal operates and the test button restores to normal, then releases this key and calls the local party in the usual manner, designates the trunk and places the receiver upon the switch hook which restores all apparatus at the attendant's station to normal, except the visual hold signal on the designated trunk line. The local party answers the attendant's trunk call as described in paragraph 5.

SYSTEM NO. 2.

INSTRUCTIONS FOR OPERATING THE LOCAL STATIONS.

1. TO CALL LOCAL PARTY—Remove the receiver, fully depress the selecting button on the line wanted, which operates the signal on the telephone called, then releasing the button allows it to return to a talking position. When the called party answers by removing the receiver, and depressing their "Home" button, you may talk.

2. TO CALL AN EXCHANGE PARTY—Remove the receiver, fully depress one of the selecting trunk buttons which connects you to the trunk line. If the lines are not in use call the exchange in the regular way.

3. TO CALL AN EXCHANGE PARTY BY WAY OF THE ATTENDANT—Remove the receiver, fully depress the attendant's selecting button which will operate the signal at the attendant's station. When the attendant answers advise the exchange party wanted, then hang up the receiver. The attendant obtains the desired exchange party in the manner explained in paragraph 8, calls the local party and the connection is completed by the local party as explained in paragraph 5.

4. TO ANSWER LOCAL PARTY—Remove the receiver, depress the "Home" button and talk.

5. TO ANSWER ATTENDANT'S TRUNK CALL—Fully depress the designated trunk button which connects your telephone to the trunk line, this restores the visual hold signal to normal and thus indicates to the attendant that the local party has answered on the designated trunk

KELLOGG SWITCHBOARD AND SUPPLY COMPANY, CHICAGO

SYSTEM NO. 2—Continued.

INSTRUCTIONS FOR OPERATING THE LOCAL STATIONS—Continued.

line. When through talking place the receiver on the switch hook and all apparatus at your station and on the trunk line will be restored to normal.

INSTRUCTIONS FOR OPERATING ATTENDANT'S STATION.

6. TO CALL LOCAL PARTY—See "Instructions for Operating Local Stations," paragraph 1.
7. TO CALL AN EXCHANGE PARTY—The attendant removes the receiver, fully depresses one of the trunk line buttons and if the line is not busy completes the call in the regular way for exchange calls.
8. TO CALL AN EXCHANGE PARTY FOR LOCAL PARTY—The attendant learns the number of the exchange party wanted, fully depresses one of the selecting trunk buttons and if the trunk is not busy the exchange party is called in the usual way for getting an exchange party. The party is then requested to wait and the attendant moves the lever of the individual key now associated with this trunk downward until the visual hold signal operates, then releases this key and calls the local party in the usual manner, designates the trunk line and places the receiver on the switch hook which restores all apparatus at the attendant's station to normal except the visual hold signal on the designated trunk. The local party answers the attendant's call as described in paragraph 5.
9. TO ANSWER LOCAL PARTY—Remove the receiver and fully depress your "Home" button, designated by means of a red top, and talk. When thru talking simply hang up the receiver.
10. TO ANSWER EXCHANGE PARTY—The attendant removes the receiver, fully depresses the selecting button on the calling trunk line, which connects the attendant's telephone to the trunk line. A party in the local system being wanted, the trunk party is requested to wait and the attendant moves the lever of the individual key associated with this trunk line downward until the visual hold signal operates, then releases this key and calls the local party in the usual manner, designates the trunk and places the receiver upon the switchhook, which restores all apparatus at the attendant's station to normal, except the visual hold signal on the designated trunk line. The local party answers the attendant's trunk call as described in paragraph 5.

SYSTEM NO. 3.

INSTRUCTIONS FOR OPERATING THE LOCAL STATIONS.

1. TO CALL LOCAL PARTY—Remove the receiver, fully depress the selecting button on the line wanted, which operates the signal on the telephone called, then releasing the button allows it to return to a talking position. When the called party answers by removing the receiver and depressing their "Home" button you may talk.
2. TO CALL AN EXCHANGE PARTY—Remove the receiver, fully depress the selecting trunk button and if the trunk line is not busy you will complete the trunk connection in the regular way for exchange connections. If the trunk line is busy you will be locked out and it will be necessary to try another trunk or wait until the busy trunk becomes idle.
3. TO CALL AN EXCHANGE PARTY BY WAY OF THE ATTENDANT—Remove the receiver, fully depress the attendant's selecting button, which will operate the signal at the attendant's station. When the attendant answers advise the exchange party wanted, then hang up the receiver. The attendant obtains the desired exchange party in the manner explained in paragraph 8, calls the local party and the connection is completed with the local party, as explained in paragraph 5.
4. TO ANSWER LOCAL PARTY—Remove the receiver, depress the "Home" button and talk.

SYSTEM NO. 3—Continued

INSTRUCTIONS FOR OPERATING THE LOCAL STATIONS—CONTINUED.

5. TO ANSWER ATTENDANT'S TRUNK CALL—Fully depress the designated trunk button which keeps the trunk line busy, also secret and connects your telephone to the trunk line, restores the visual hold signal to normal, and thus indicates to the attendant that the local party has answered on the designated trunk line. When thru talking place the receiver on the switch hook and all apparatus at your station and on the trunk line will be restored to normal.

INSTRUCTIONS FOR OPERATING ATTENDANT'S STATION.

6. TO CALL LOCAL PARTY—See "Instructions for Operating Local Stations" paragraph 1.

7. TO CALL AN EXCHANGE PARTY—The attendant removes the receiver, fully depresses one of the trunk line buttons and if the trunk is not busy this will make it so, and no other party can use it. The exchange call is then completed in the regular way for exchange calls.

8. TO CALL AN EXCHANGE PARTY BY WAY OF THE ATTENDANT—The attendant learns the number of the exchange party wanted, fully depresses one of the selecting trunk buttons and if the trunk is not busy the secret device on the key will now operate to make it busy so no one else can take it. The attendant is now connected to the exchange line and secures the exchange party in the regular way. The party is requested to wait, and the attendant moves the lever of the individual key, now associated with this trunk, downward until the visual hold signal operates, then releases this key and calls the local party in the usual manner, designates the trunk line and places the receiver on the switch hook, which restores all apparatus at the attendant's station to normal except the visual hold signal on the designated trunk. The local party answers the attendant's call as described in paragraph 5.

9. TO ANSWER LOCAL PARTY—Remove the receiver and fully depress your "Home" button, designated by means of a red top, and talk. When thru talking simply hang up the receiver.

10. TO ANSWER EXCHANGE PARTY—The attendant removes the receiver, fully depresses the selecting button on the calling trunk line which makes this line busy and connects the attendant's telephone to the trunk line. Another party in the local system being wanted the trunk party is requested to wait, and the attendant moves the lever of the individual key now associated with this trunk downward until the visual hold signal operates, then releases this key and calls the local party in the usual manner, designates the trunk and places the receiver upon the switch hook, which restores all apparatus at the attendant's station to normal, except the visual hold signal on the designated trunk line. The local party answers the attendant's trunk call as described in paragraph 5.

SYSTEM NO. 4.

INSTRUCTIONS FOR OPERATING THE LOCAL STATIONS.

1. TO CALL LOCAL PARTY—Remove the receiver, fully depress the selecting button on the line wanted, release, and if the line is not in use hold the switch hook down and turn the generator crank which operates the signal on the telephone being called. When called party answers by removing their receiver and pressing their "Home" button you may talk.

2. TO CALL AN EXCHANGE PARTY—Remove the receiver, fully depress the selecting trunk button on the line wanted, release, and if the line is not in use hold the switch hook down and turn the generator crank, this operates the signal at the exchange in the usual manner.

3. TO CALL AN EXCHANGE PARTY BY WAY OF THE ATTENDANT—Remove the receiver, fully depress the attendant's selecting button and if the line is not busy turn your generator crank, which signals the attendant. When the attendant answers advise the exchange party wanted, then hang up the receiver. The attendant obtains the desired exchange party in the manner explained in paragraph 8, calls the local party and the conversation is completed by the local party as explained in paragraph 5.

LOGG SWITCHBOARD AND SUPPLY COMPANY, CHICAGO

SYSTEM NO. 4—Continued.

INSTRUCTIONS FOR OPERATING THE LOCAL STATIONS.

4. TO ANSWER LOCAL PARTY—Remove the receiver, depress the "Home" button and talk.
5. TO ANSWER ATTENDANT'S TRUNK CALL—Fully depress the designated trunk button, which connects your telephone to the trunk line, restores the visual hold signal to normal, and thus indicates to the attendant that the local party has answered on the designated trunk line. When thru talking place the receiver on the switch hook.

INSTRUCTIONS FOR OPERATING ATTENDANT'S STATION.

6. TO CALL LOCAL PARTY—See "Instructions for Operating Local Stations," paragraph 1.
7. TO CALL AN EXCHANGE PARTY—The attendant removes the receiver, fully depresses one of the trunk line buttons and if the line is not busy completes the call in the regular manner for exchange calls.
8. TO CALL AN EXCHANGE PARTY FOR LOCAL PARTY—The attendant learns the number of the exchange party wanted, fully depresses one of the selecting trunk buttons and if the trunk is not busy the exchange party is called in the usual way. The trunk party is requested to wait, and the attendant then calls the local party in the usual manner, designates the trunk line and places the receiver on the switch hook. The local party answers the attendant's call as described in paragraph 5.
9. TO ANSWER LOCAL PARTY—Remove the receiver and fully depress your "Home" button, designated by means of a red top, and talk. When thru talking simply hang up your receiver.
10. TO ANSWER EXCHANGE PARTY—The attendant removes the receiver, fully depresses the selecting button on the calling trunk line, which connects the attendant's telephone to the trunk line. Another party in the local system being wanted, the trunk party is requested to wait. The attendant calls the local party in the usual manner, designates the trunk and places the receiver on the hook. The local party answers the attendant's trunk call as described in paragraph 5.

CIRCUIT CA-66 CALL AND RETURN

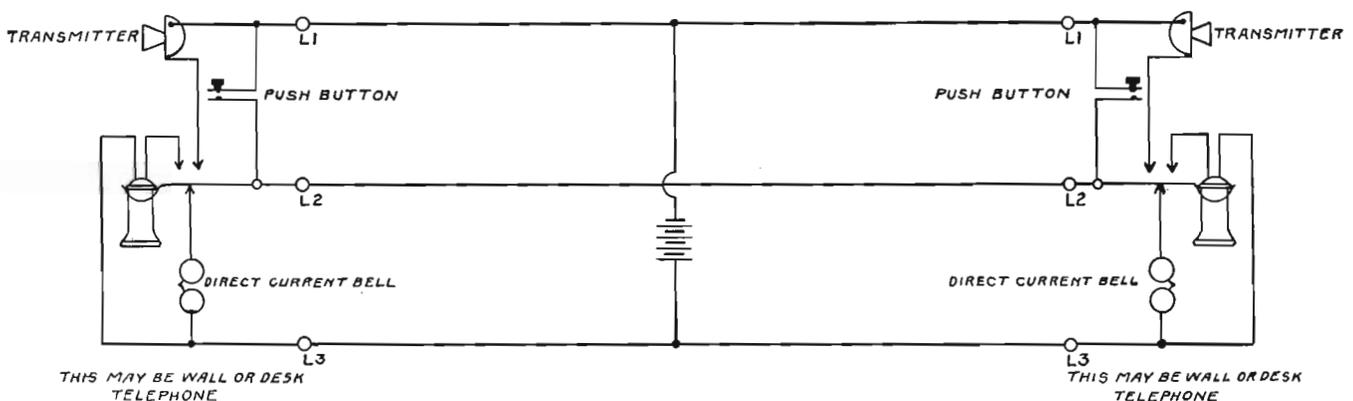

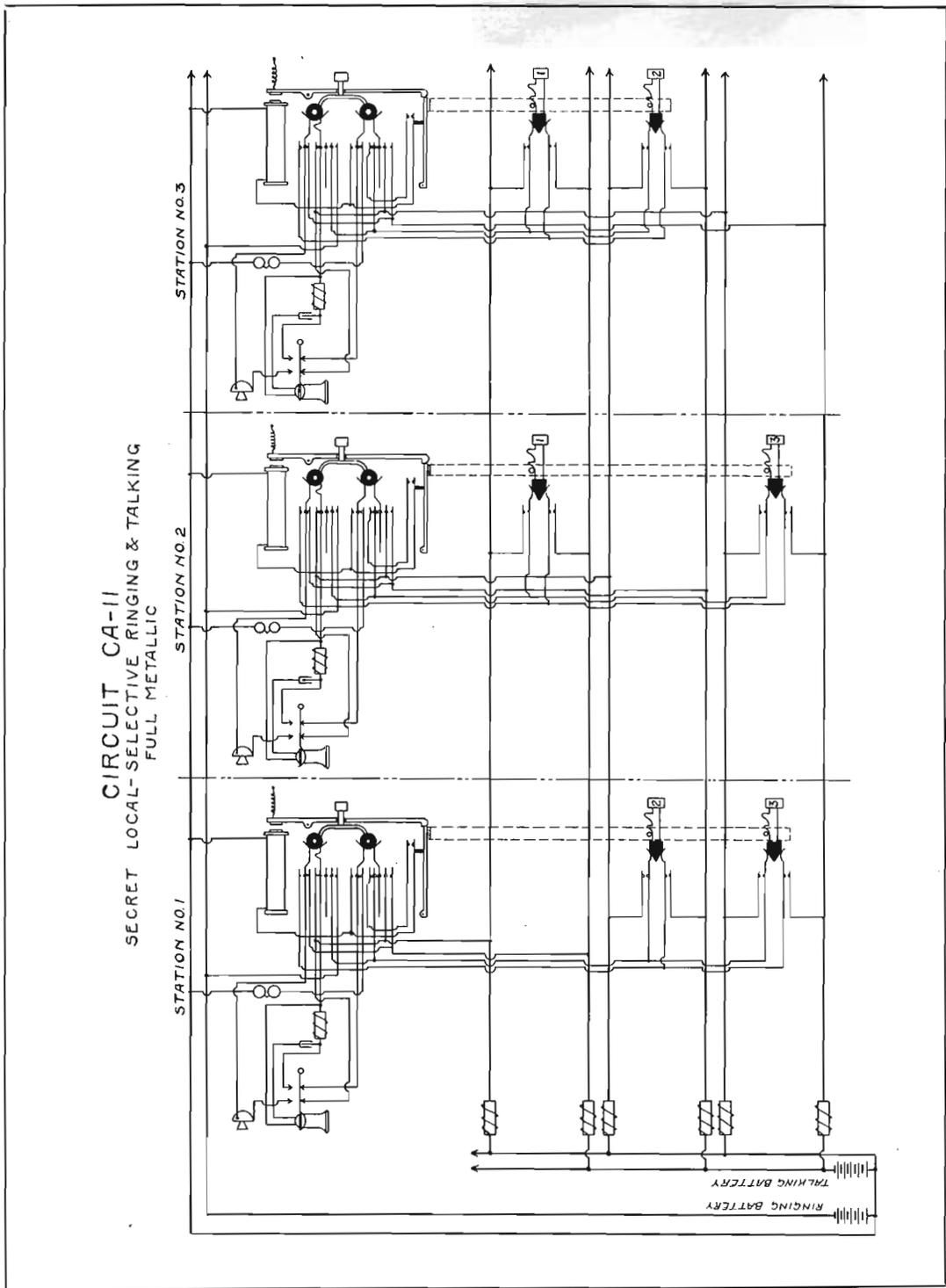

CIRCUIT CA-II
SECRET LOCAL-SELECTIVE RINGING & TALKING
FULL METALLIC

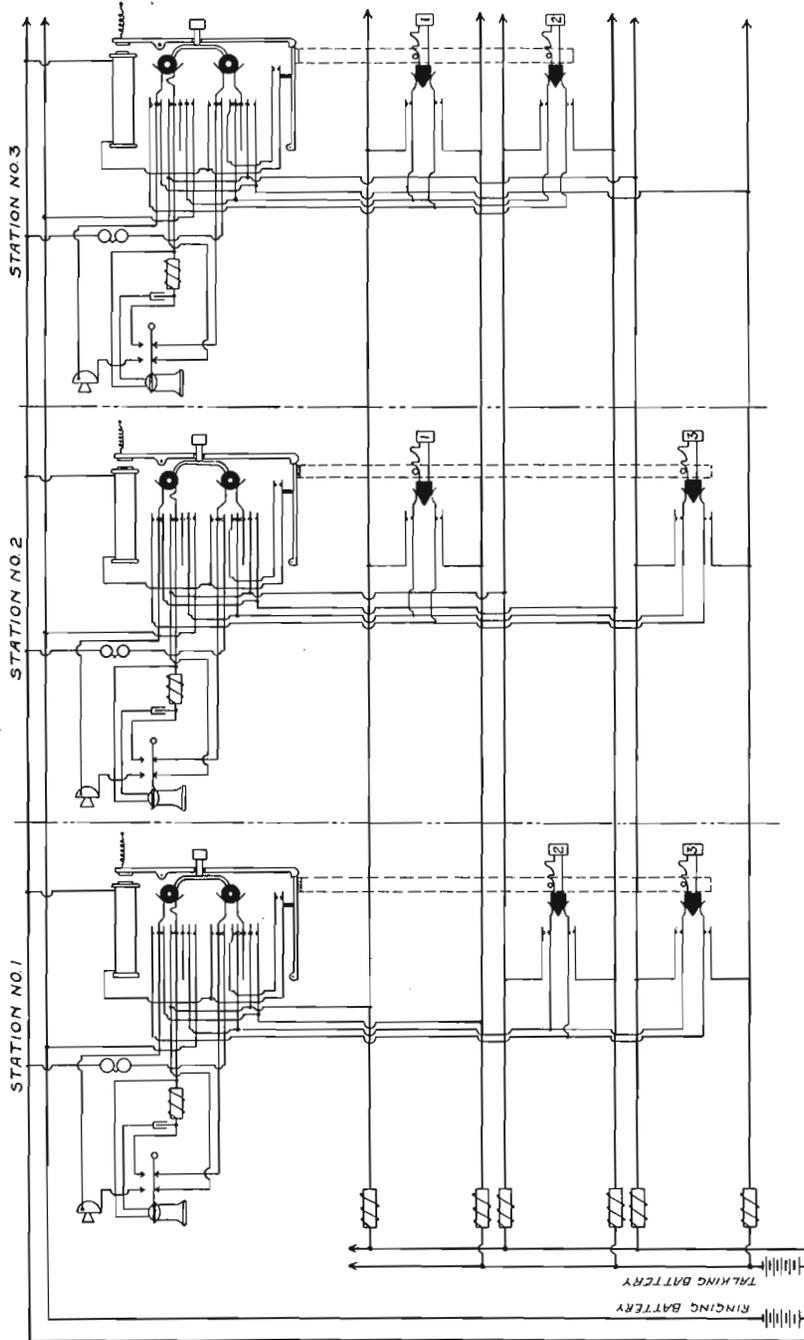

CIRCUIT CA-35.
 AUTOMATIC NON-SECRET INTERIOR SYSTEM.

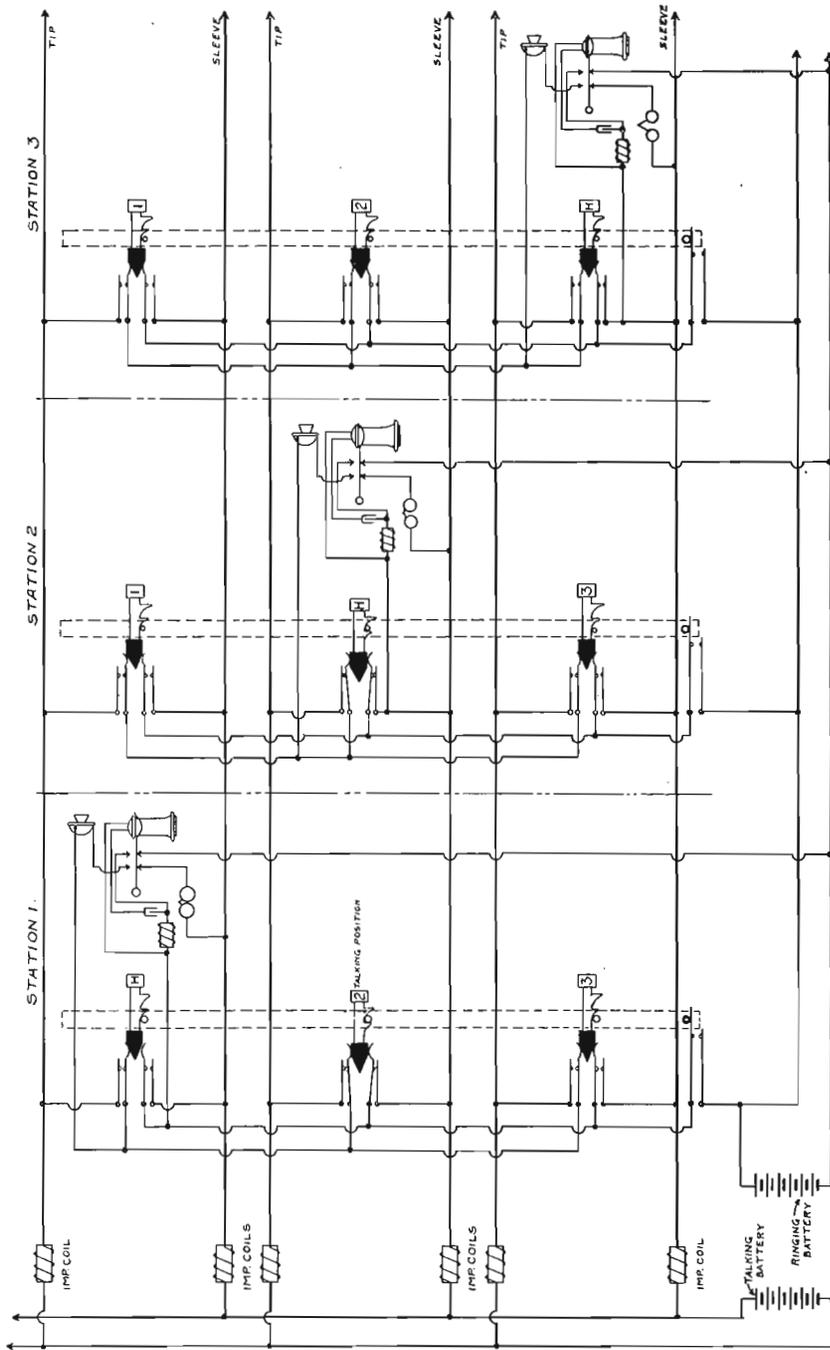

CIRCUIT CA-60.
AUTOMATIC INTERIOR MAGNETO SYSTEM.

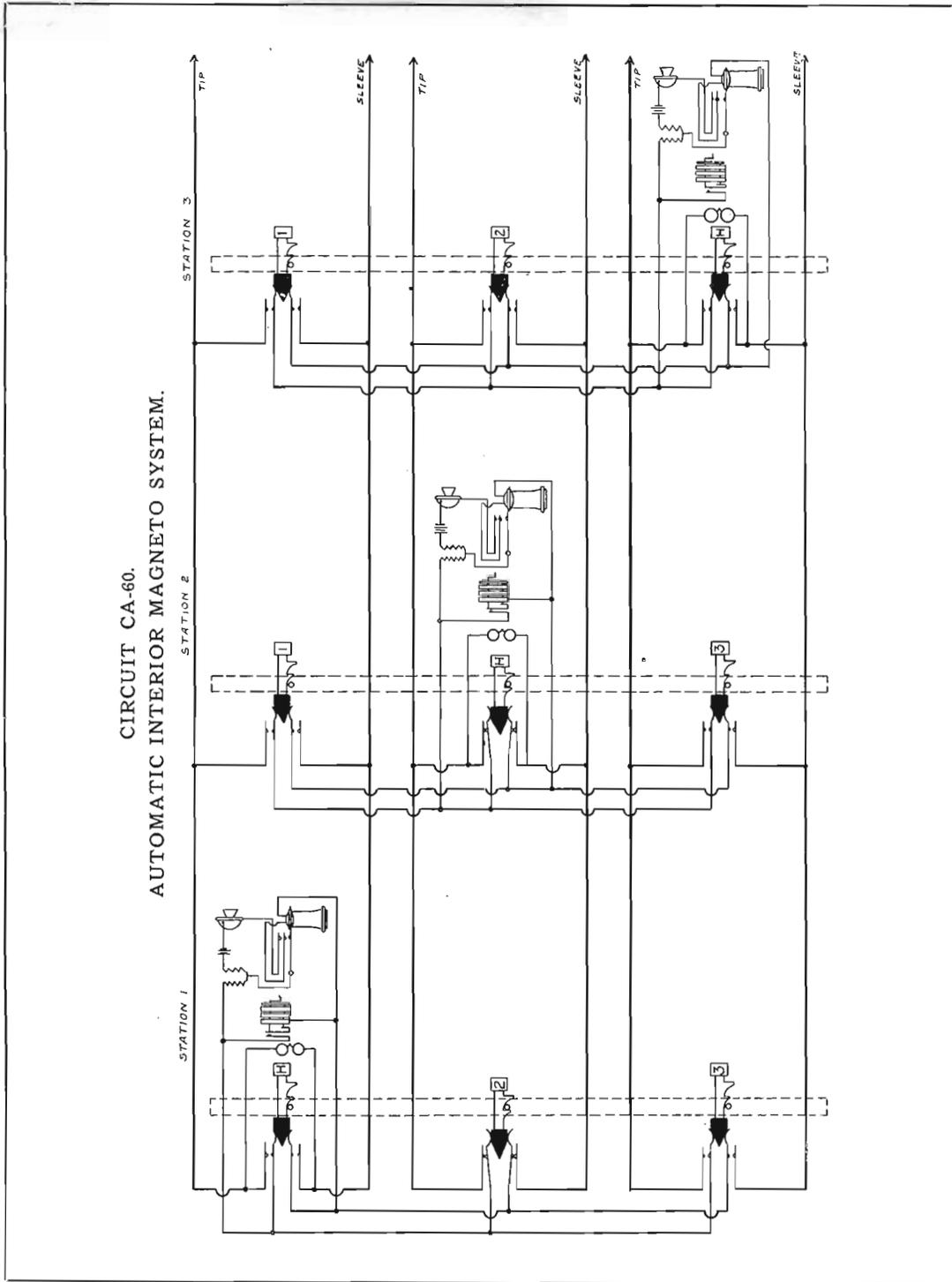

CIRCUIT CA-70.
ATTENDANT'S STATION—NON-SECRET
TWO WIRE COMMON BATTERY MANUAL OR AUTOMATIC

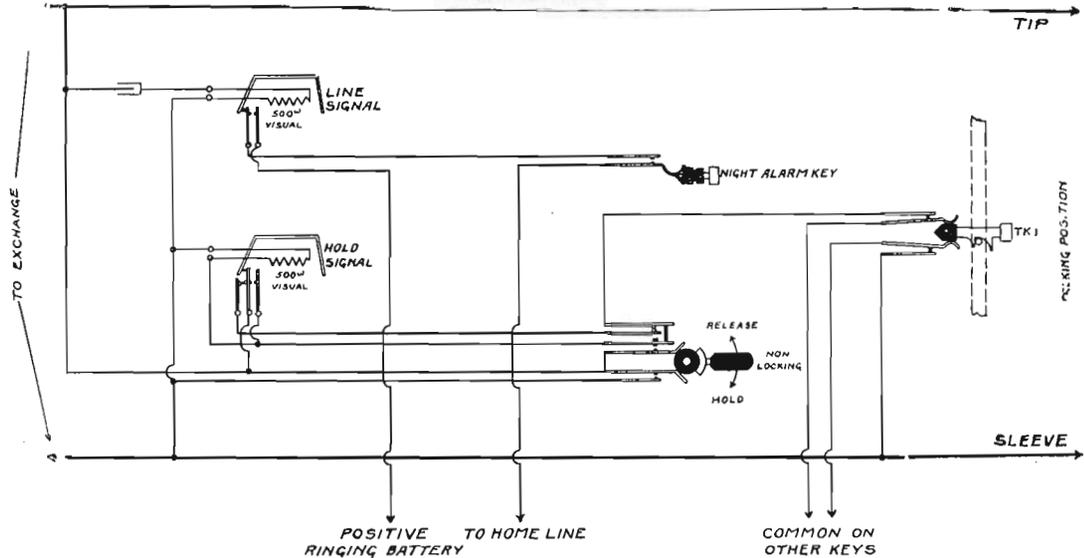

This theoretical circuit diagram shows a trunk line and all connections to equipment necessary for one trunk. The trunk button on the telephone is shown in a talking position. For systems No. 2 and No. 3.

CIRCUIT CA-75.
ATTENDANT'S STATION—SECRET
TWO WIRE COMMON BATTERY MANUAL OR AUTOMATIC

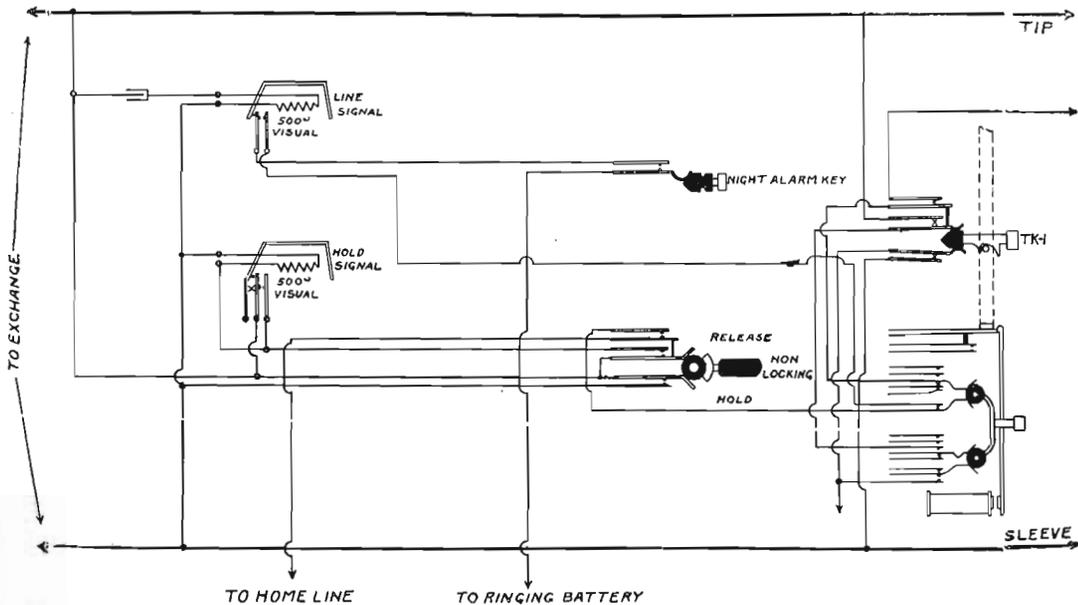

This theoretical circuit diagram shows a trunk line and all connections to equipment necessary for one trunk. The trunk button on the telephone is shown in a talking position. For system No. 1, see Circuit CA-11. For system No. 3, see Circuit CA-52.

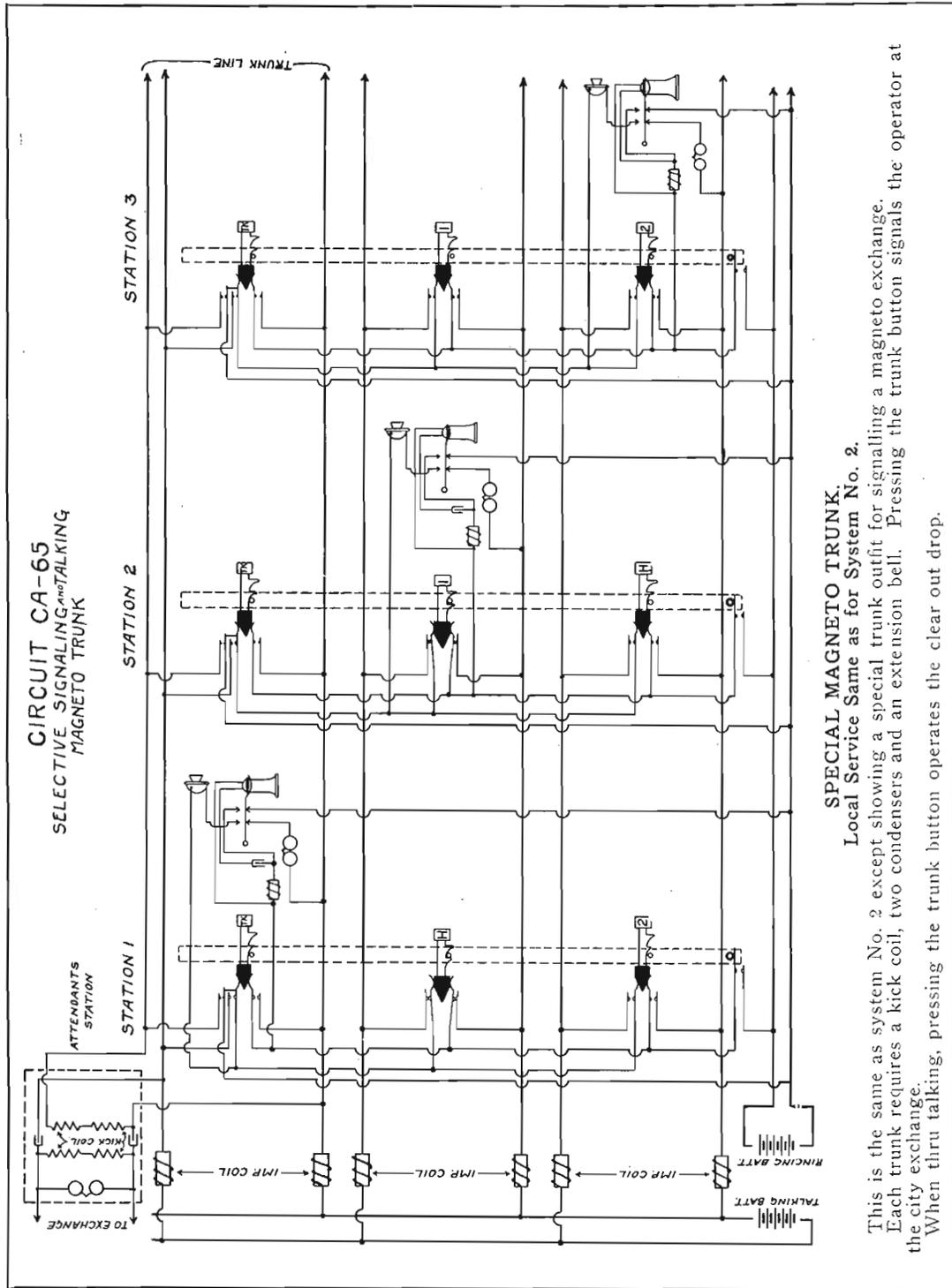

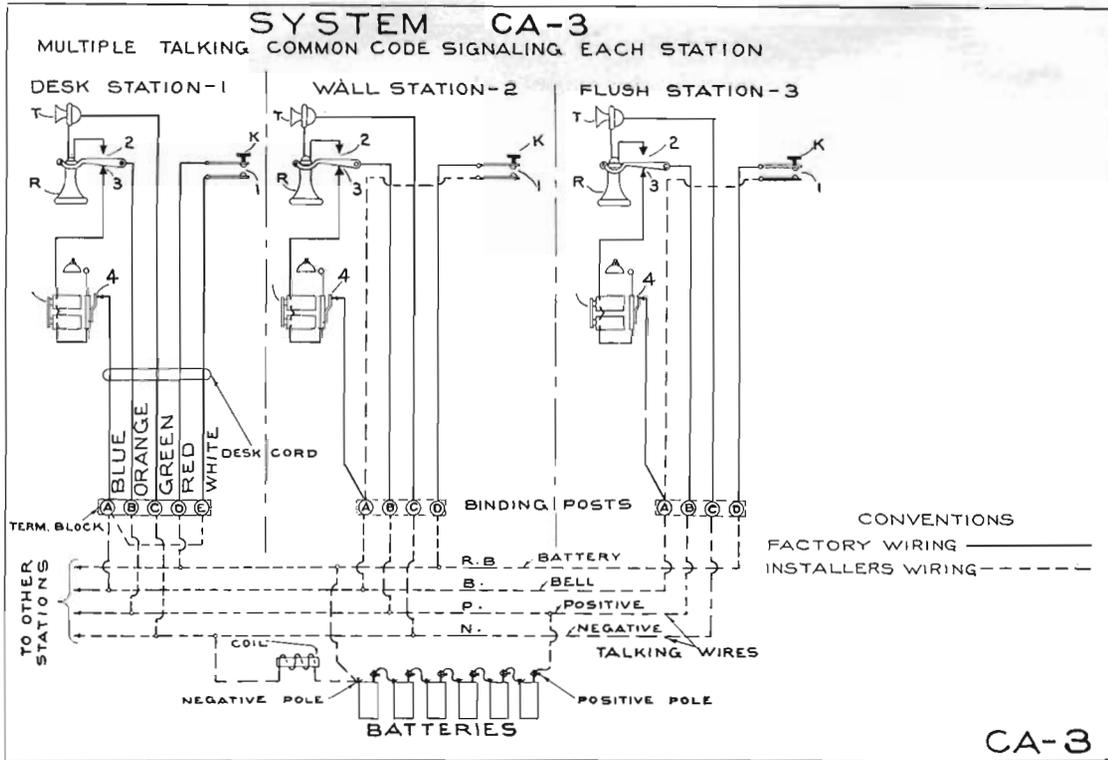

WIRING, OPERATION AND CIRCUIT DESCRIPTION.

This system is recommended for installations where a simple system is desired, and where one conversation at a time will suffice.

WIRING—Requires four (4) common wires multiplied through each telephone, as shown in above drawing.

OPERATION—Each party in the system answers a code ringing signal:

- No. 1 party—1 long ring.
- No. 2 party—2 long rings.
- No. 3 party—1 short ring.
- No. 4 party—2 short rings.
- No. 5 party—1 long, 1 short ring.
- No. 6 party—1 short, 1 long ring.

To Call—Remove the receiver, then depress the button of your telephone the number of times corresponding to the code signal of the party wanted.

To Answer—Go to the nearest telephone when your code signal rings, remove the receiver and talk.

Pay no attention to any other code signal ring except your own.

The ringing circuit may be traced from the negative pole of the battery, wire marked R. B., binding post D at calling station, contact 1 of button K at the calling station, binding post A at the calling station, wire marked B, contacts 4 and windings of all bells, contact 3 of all normally engaged hook switches, binding post B, and wire marked P to the positive pole of the battery.

The battery supply talking circuit may be traced from the negative pole of the battery through the impedance coil, wire marked N, binding post C of the telephones connected for talking, transmitters T, receivers R, engaged hook switch contacts 2, binding post B of all telephones connected for talking, and wire marked P to the positive pole of the battery.

EXAMPLE ORDER.

This selection is based on an installation for 4 stations.

Code Number	No.	Description	Price
8672	2	Desk stand with single button.....@	\$16.55
8194	2	Wall set with single button.....@	8.80
16-C	1	Retardation coil.....@	.65
			\$41.35

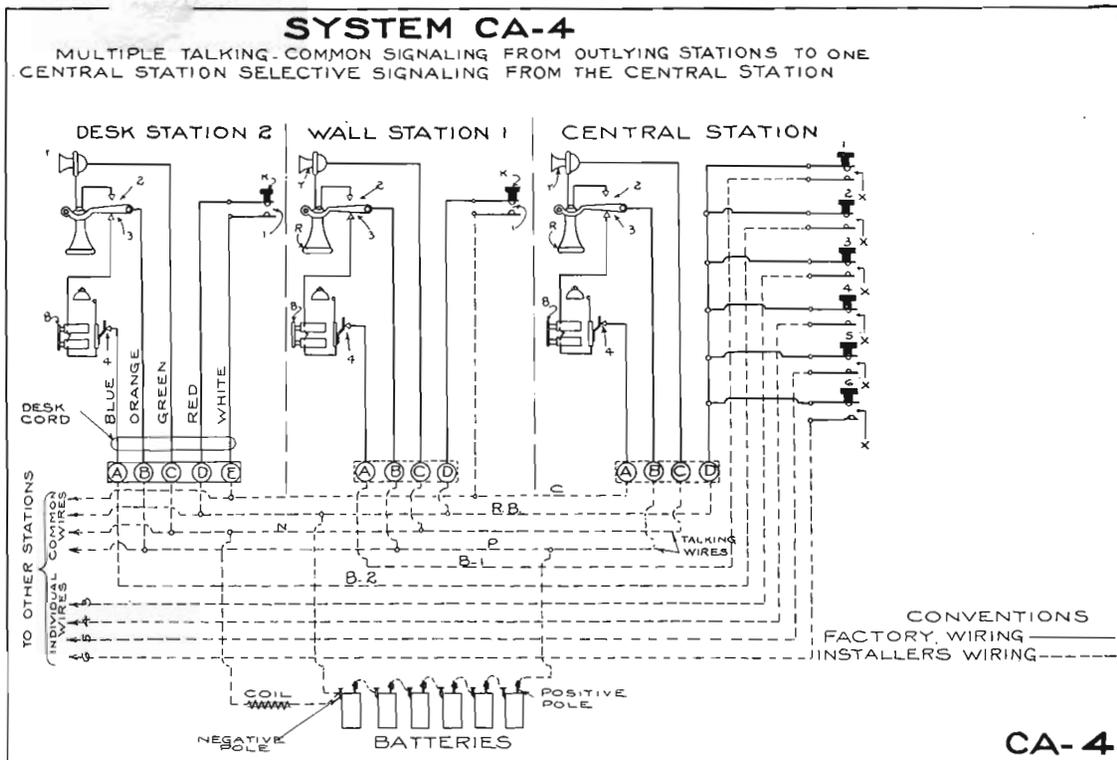

WIRING, OPERATION AND CIRCUIT DESCRIPTION.

This System CA-4 is designed for use in factories, schools and hospitals.
SERVICE—Outlying station to the central station; central station to each outlying station; outlying station to outlying station by way of the central station.

WIRING—Requires four common wires to all the telephones; one individual wire from central station to each outlying station.

OPERATION—Central station calling an outlying station: To Call—Remove the receiver from the switch hook and fully depress the button corresponding to the number of the outlying station wanted, which rings the bell at that station.

To Answer the Call—Remove the receiver and talk.

Outlying station calling the central station: To Call—Remove the receiver from the switch hook and fully depress the ringing button, which rings the bell at the central station.

To Answer the Call—Remove the receiver and talk.

Outlying station calling another outlying station: Remove the receiver and call the central station as explained above, then inform the central party the number of the station wanted, and the central party will call the wanted outlying station in the manner described above. When the called party answers, the two parties are connected for talking, and thereupon the central party places receiver upon the switch hook.

RINGING CIRCUITS—Circuit of central station calling an outlying station may be traced from the negative pole of the battery, wire R. B., contact X of the button depressed, wire B-1 or B-2, contact 4, winding of the bell B, contact 3 of the station being called, wire P to the positive pole of the battery.

Circuit of an outlying station calling the central station may be traced from the negative battery; wire R. B., contact 1 of the button K depressed, wire C, contact 4, winding of bell, contact 3 at the central station, wire P to the positive pole of the battery.

TALKING CIRCUIT—The battery supply circuit may be traced from negative battery, winding of coil, wire marked N, transmitter T, receivers R, engaged switch hook contacts 2 of the telephones connected for talking, wire marked P to the positive battery.

EXAMPLE ORDER.

This selection is based on an installation of 4 outlying stations.

Code Number	No.	Description	Price
8194	3	Wall sets single button.....@	\$ 8.80
8672	1	Desk set single button.....@	16.55
8672	1	Desk set five buttons.....@	21.95
16-C	1	Retardation coil.....@	.65

\$65.55

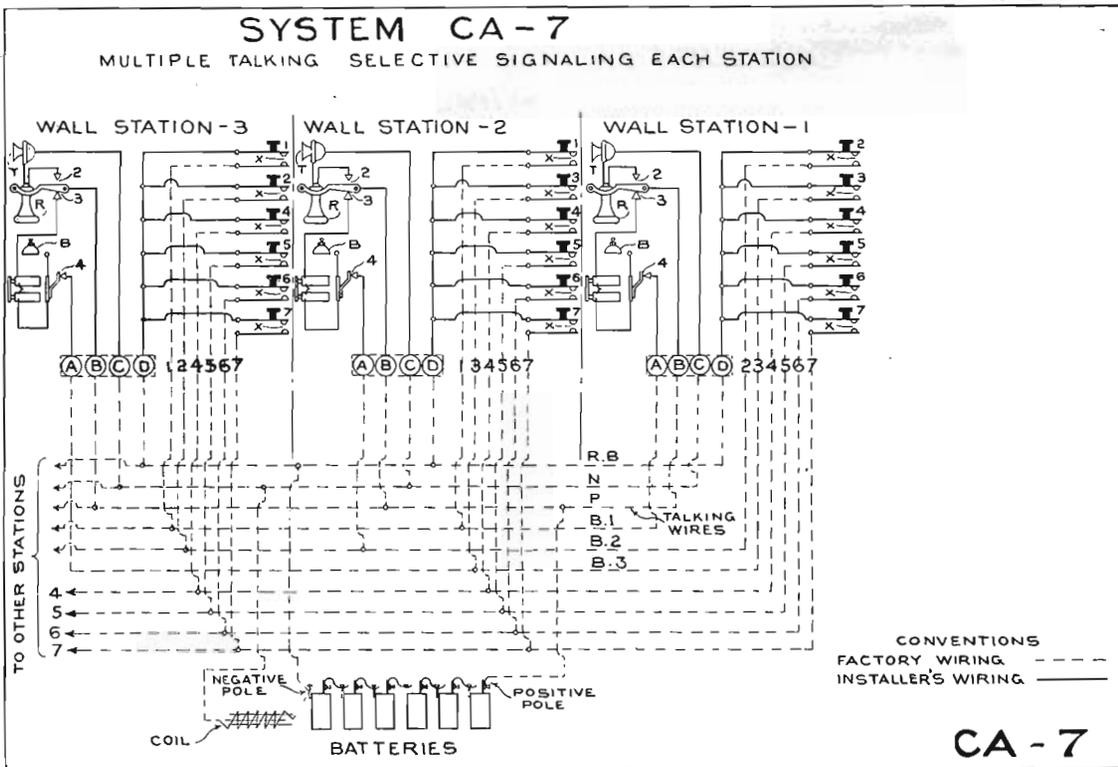

WIRING, OPERATION AND CIRCUIT DESCRIPTION.

SYSTEM CA-7 Interior System, multiple talking, selective signaling, designed for installations where one conversation at a time will suffice, but where it is desired to call each telephone separately from any station in the system.

SERVICE—Each station can call any other station separately and talk with one another.

WIRING—Requires three common wires, plus one wire for each telephone installed, multiplied through all the telephones.

OPERATION—To Call: Remove the receiver from the switch hook and fully depress the ringing button corresponding to the number of the station wanted, which rings the bell at that station.

To Answer: Remove the receiver and talk.

RINGING CIRCUIT—The ringing circuit may be traced from the negative pole of the battery; contact X of the button depressed, wire B-1, B-2 or B-3, depending upon the station wanted, contact 4, winding of the bell B, and contact 3 of the station being called, wire P to the positive pole of the battery.

TALKING CIRCUIT—The battery supply circuit may be traced from the negative pole of the battery, winding of the coil, wire N; transmitters T, receivers R, contacts 2 of the engaged switch hooks of the telephones connected for talking, wire P to the positive pole of the battery.

REMARKS—This system is recommended for installations in schools, hospitals, apartment houses, factories, etc., where one conversation at a time will suffice.

EXAMPLE ORDER.

This selection is based on an installation of 6 telephones.

Code Number	No.	Description	Price
8194	4	Wall sets, five buttons.....@	\$13.80
8672	2	Desk sets, five buttons.....@	21.95
16-C	1	Retardation coil	@ .65
			\$98.75

CHARGING AND BATTERY SUPPLY CIRCUIT CA-18
 FOR SELF-OPERATING SECRET SYSTEMS WORKING IN CONNECTION WITH COMMON BATTERY EXCHANGES.

FIGURE - A
 CIRCUIT FOR CHARGING BATTERY OVER THE TRUNK LINE

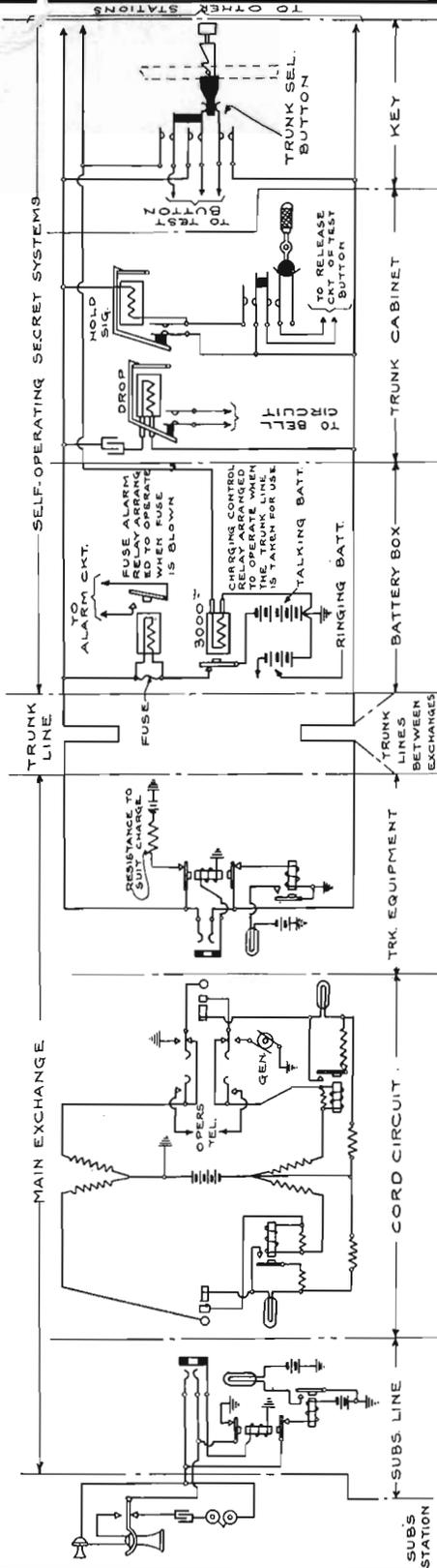

FIGURE - B
 CHARGING CIRCUIT
 VOLTAGE REGULATED BY MEANS OF C.E.M. CELLS
 AT THE MAIN EXCHANGE

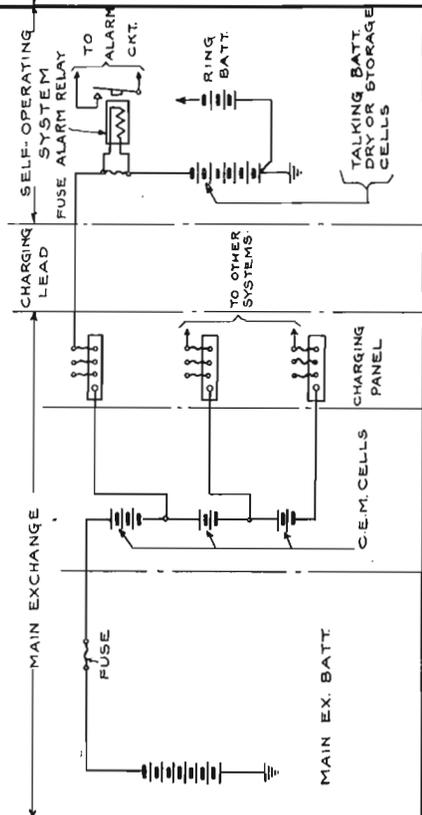
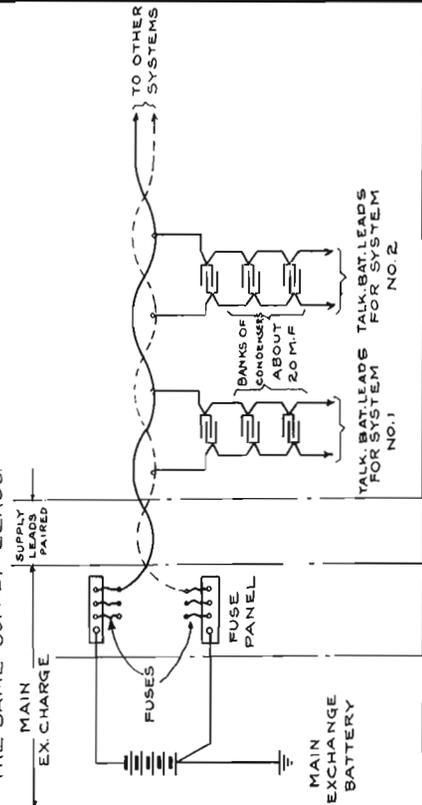
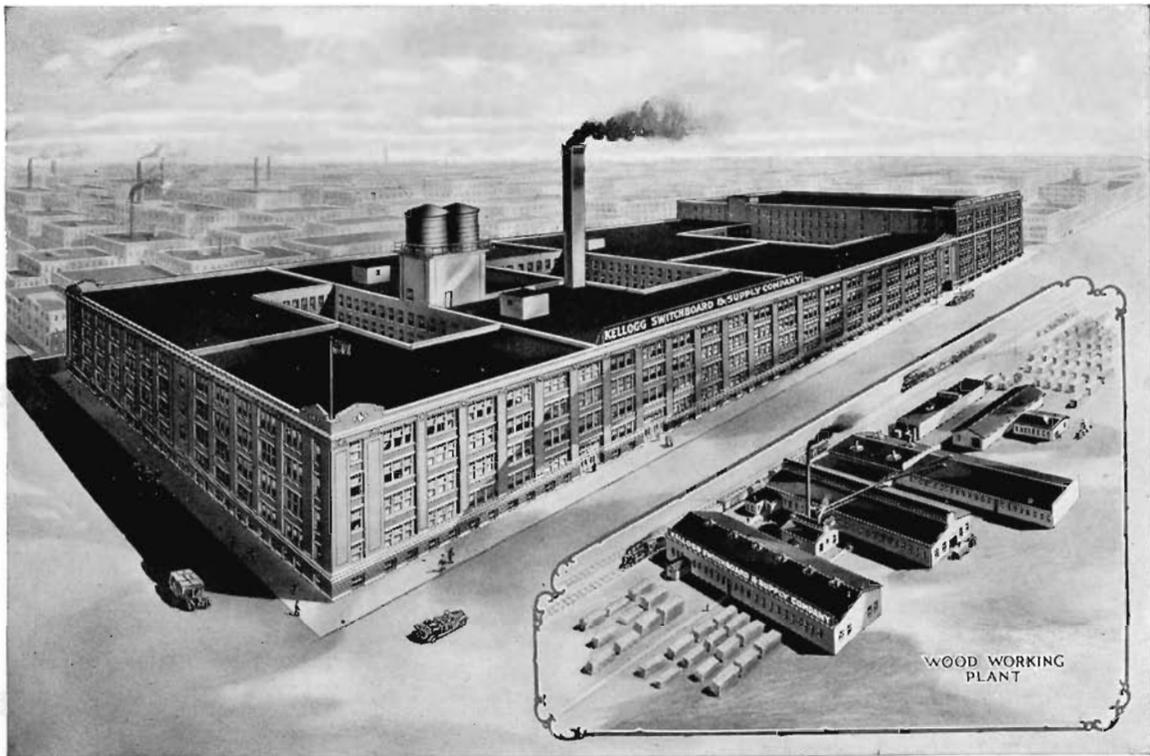

FIGURE - C
 USED BY THE HOME TEL. CO. OF SAN FRANCISCO CAL PAIRED
 SUPPLY LEADS ELIMINATE CROSS TALK AND PERMITS
 SEVERAL SYSTEMS TO BE SUPPLIED WITH CURRENT FROM
 THE SAME SUPPLY LEADS.



A PARTIAL LIST OF WHAT WE MAKE— USE IS THE TEST

Farm Line Telephones	Transmitters
Magneto Switchboards	Impedance Coils
High Efficiency Common Battery Telephones	Kellogg Bakelite Mouthpieces
Universal Telephones	Kellogg Bakelite Operators' Receivers
Portable Telephones	Kellogg Bakelite Receivers
Weatherproof Telephones	Cordage
Special Insulated Telephones	Generators
Convertible Telephones	Condensers
Railway Telephones	Switchboard Lamps
Mine Telephones	Lamp Caps
Booth Telephones	Plugs
Grabaphones	Ringers
Cut-in Stations	Retardation Coils
Automatic Interior Systems	Induction Coils
Test Sets	High Efficiency Repeating Coils
Howlers	Relays
Universal Switchboards	Drops and Jacks
Cord Weights	Order Wire Keys
Instantaneous Recall Switchboards	Plug Seat Switches
P. B. X. Equipment	Buzzers
Toll Boards	Switchboard Cable, Silk and Enamel
Wire Chief's Desks	Magnet Wire, Silk and Enamel
Chief Operator's Desks	Flame Proof Jumper Wire
Monitor's Desks	Terminal Blocks
Supervisor's Desks	Resin Core Solder
Cordless P. B. X. Switchboards	Lightning Arresters
Harmonic Systems	Heat Coils
Harmonic Converters	Main Frames
Multiple Switchboards	Lacing Twine
Automatic Ringing Relay Inter- rupters	Switchboard Tools
Test Panels	Loud Ringing Extension Bells
Power Boards	Transformer Sets
Pole Changers	Transformers
Police and Fire Alarm Systems	Ringin and Listening Keys
Marine Telephone and Switchboard Equipment	Switching Keys
Despatching Systems	Switches
Toll Test Panels	Cabinets for Telephone Requirements
	Electric Light Current Converters



Kellogg Switchboard & Supply Company

CHICAGO, ILLINOIS

Branch Offices: Kansas City, Mo., San Francisco, Cal.

Columbus, Ohio

Installing Instructions for Kellogg Automatic Interior Telephones

Bulletin No. 15

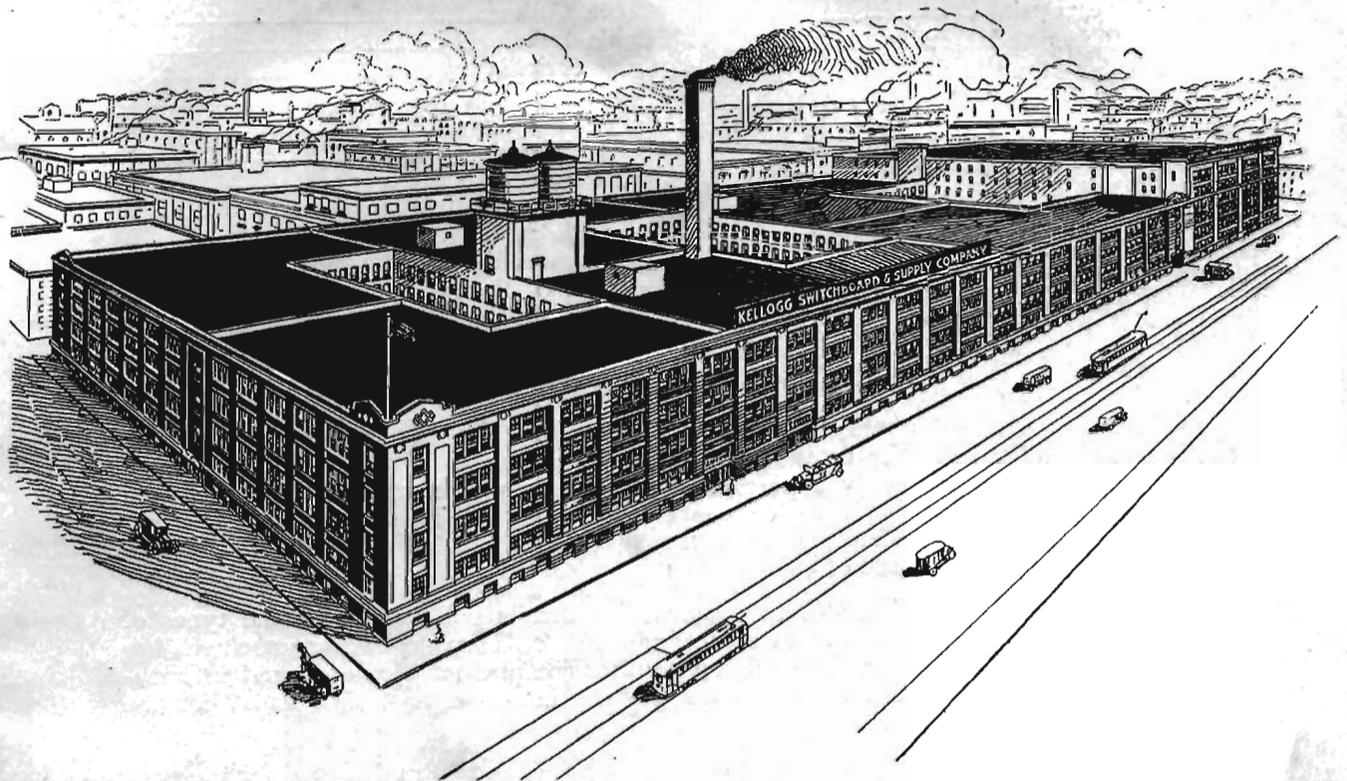

A Partial List of What We Make "Use is the Test"

Farm Line Telephones	Pole Changers	Ringers
Common Battery Telephones	Marine Telephone and Switchboard Equipment	Induction Coils
Portable Telephones	Railway Dispatching Systems	Repeating Coils
Railway Telephones	Electric Light Current Converters	Relays
Grabaphones	Transmitters	Switchboard Cable Silk and Enamel
Magneto Switchboards	Kellogg Bakelite Receivers	Magnet Wire Silk and Enamel
Private Branch Exchange Switchboards	Cordage	Terminal Blocks
Cordless Private Branch Exchange Switchboards	Generators	Loud Ringing Extension Bells
Test Sets	Condensers	Ringling and Listening Keys

We can ship promptly line supplies for all construction work. Our Poles, Wire, Insulators, Pins, Brackets, Tools, Etc., are of the highest quality.

Kellogg Switchboard & Supply Company

Chicago, Illinois

BRANCH OFFICES:

Kansas City, Mo.

Columbus, Ohio

San Francisco, Cal.

CONTENTS

	Page		Page
General Description.....	2	Cable Codes.....	18
Battery Boxes and Details.....	15	Cable Splicing.....	12
Brackets for Mounting Key Boxes.....	16	Cable Stripping.....	13
Cabling Plan—Mill Constructed Building	4	Cable Butting.....	13
Cabling Plan—Office Building.....	5	Cable Forming.....	13
Cabling Plan—Apartment Building.....	6	Cable Waxing.....	14
Cabling Plan—General	7	Cable Soldering.....	14
Cabling Plan—Details.....	8-9-10	Dimensions of Key Boxes.....	19
Cabling of Junction Blocks.....	17	Dimensions of Wall Telephone.....	19
		Dimensions of Junction Blocks.....	19
		Method of Fastening Telephones.....	11

GENERAL DESCRIPTION

The object of this bulletin is to enable you to select and use the proper construction material and to give the details for installing the Automatic Interior Systems listed in our catalog. It covers only a portion of the construction material and details used in telephone work but the information contained in this bulletin, together with the suggestions given under the following headings will aid you in ordering the proper material and using the proper methods of construction.

CONSTRUCTION DETAILS—The construction details will vary with the types of buildings in which the installation is made and will also vary depending upon whether the installation is made during construction or after completion. Some general information is given on page 3 and cabling plans are shown on pages 4, 5, 6 and 7 for the different classes of buildings.

CABLES—The cables listed on page 19 of catalog No. 4 have been designed for use with these systems. They are all made to standard specifications.

CONDUIT AND CONDUIT FITTINGS—We are prepared to furnish conduit and fittings upon request, but recommend that this material be obtained from the supply houses handling this line.

BATTERY BOXES—The battery boxes shown on page 15 are designed to permit the use of any standard make of batteries. The batteries are arranged and mounted so that tests, repairs, and renewals can be easily made. Space has also been provided for mounting the coils in the boxes, which reduces the length of the wires from the batteries to the coils and thereby eliminates the possibility of any cross talk from this source.

JUNCTION BLOCKS—We recommend our latest type combination screw and solder junction block as shown on page 17. There is a special fanning strip on this block which does away with the necessity of forming and lacing cable. It is of course, good practice to solder all connections but we have made provision for those who wish to use a screw terminal. We can also furnish a standard lock nut type of terminal. Both are shown on page 17.

If you are interested in Private Branch Exchange systems for large installations, or magneto, switchboards and telephones, for towns and villages, or in the most efficient equipment for large cities, write us.

KELLOGG SWITCHBOARD AND SUPPLY COMPANY

Manufacturers of Standard Telephone Equipment

Prompt Shipments of Supplies, Line and Pole Hardware, Wire, Poles

INFORMATION APPLYING TO INSTALLATION OF AUTOMATIC INTERIOR SYSTEMS

This information and associated drawings cover in a general way construction details and instructions for installing Automatic Interior Systems in Mill Constructed, Office, Apartment and Frame buildings.

The continued and satisfactory operation of a system depends a great deal on the right judgment and workmanship of the contractor. Keep in mind always a good installation and the result will be good service.

CABLE ROUTES—In laying out cable routes in all types of buildings the following general rules should be followed:

1—Take plenty of time to select proper routes for your cable runs as saving of cable results.

2—Run cables as shown in drawings on pages 4 to 10.

3—Cables must be placed where they will be free from mechanical injury or moisture; select routes accordingly.

4—Avoid straight drops from the ceiling to the telephone, where the cable is suspended in the air without support.

5—Junction blocks and splices should be placed so as to take care of the maximum number of telephones. Proper grouping will result in saving of labor on installation and maintenance.

CABLES AND WIRES—Lead covered cables should be used in wet and damp places.

Protect cables as shown in drawings on page 9.

Fasten cables with proper cleats and often enough so there will be no sagging. Do not use staples.

Strip, butt, wax and form cables as shown on page 13.

Sharp bends should not be made in cables.

Fasten all individual or paired wires in a workmanlike manner and according to standard practice.

CABLE SPLICES—We do not recommend splicing cables but rather the use of junction blocks as at times it becomes convenient in case of additions or moves to tap on to these splices or junction blocks. See page 12.

JUNCTION BLOCKS—The saving of labor and maintenance warrants their use in all installations where cable is used.

MOUNTING OF APPARATUS—Place the battery box as near the center of the system as possible. Do not install in a damp place or where it is inconvenient to get at. See page 15 for battery box information.

The pedestal and universal bracket shown on page 16 should be used for mounting desk and attendant outfits. We also show the use of our popular Sperry Bracket in connection with desk outfits. See page 17.

CABLING PLANS FOR MILL-CONSTRUCTED BUILDINGS

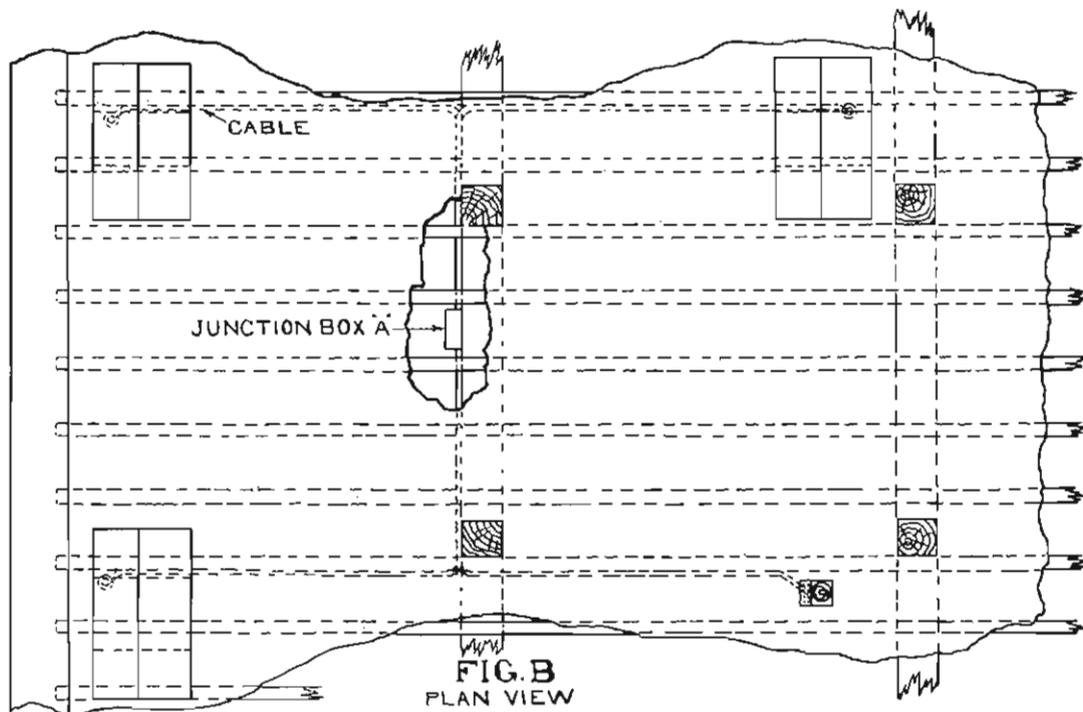
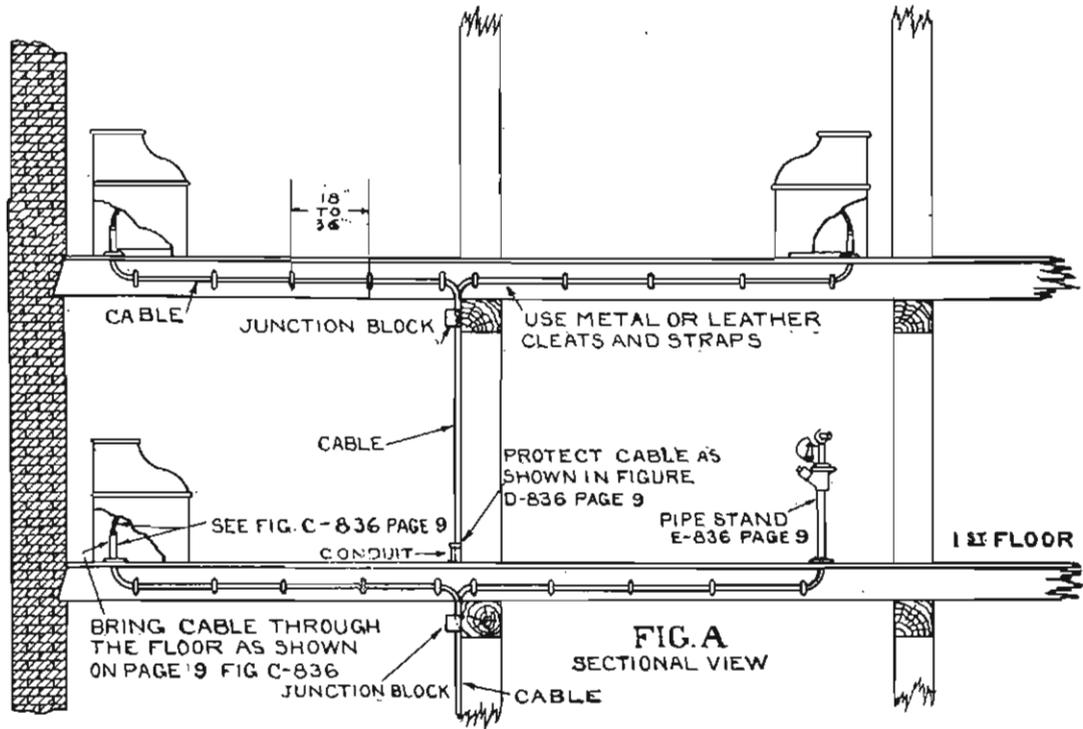

CABLING PLANS FOR OFFICE BUILDINGS

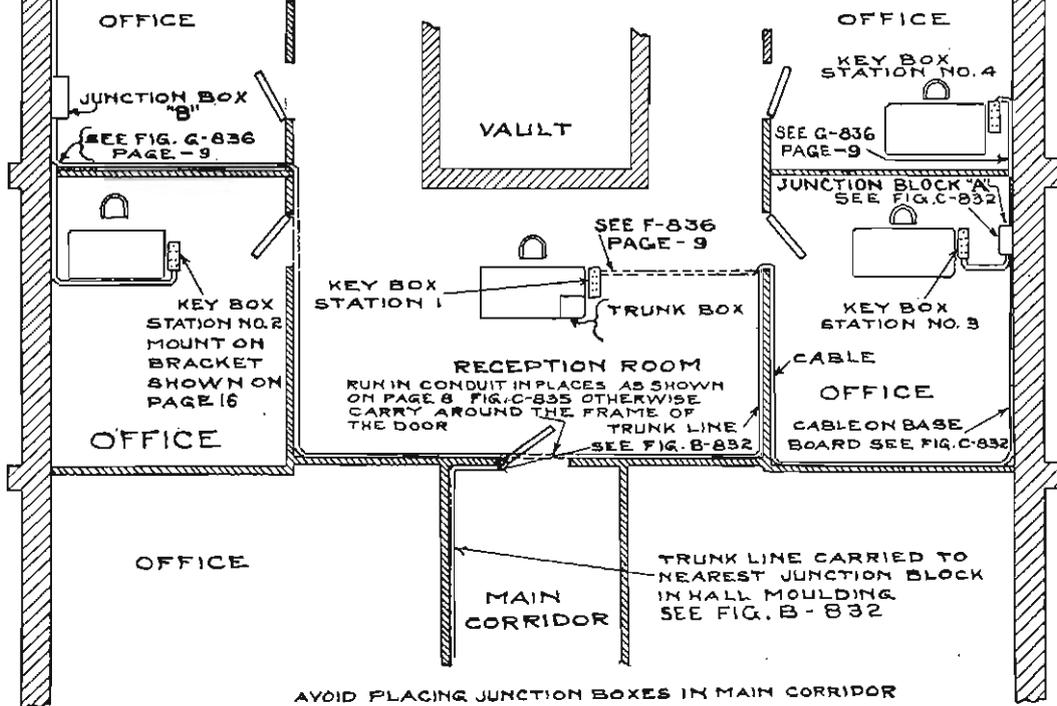

A-832 PLAN VIEW

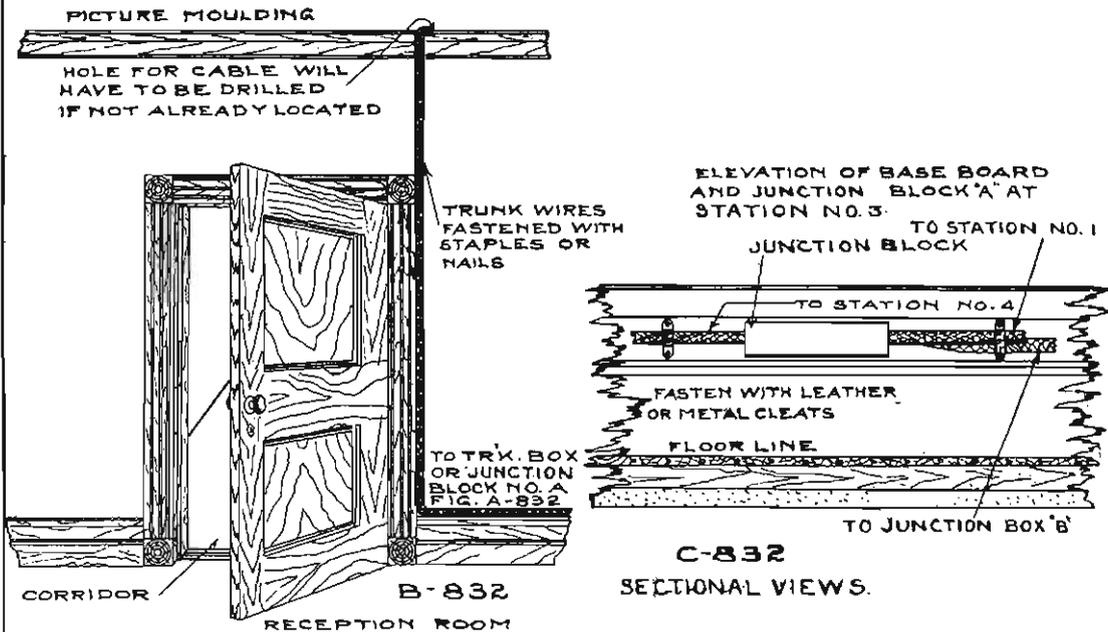

C-832
SECTIONAL VIEWS.

CABLING PLAN FOR APARTMENT BUILDING

FIG. A
SMALL SCALE PLAN
VIEW OF MODEL
APARTMENT HOUSE

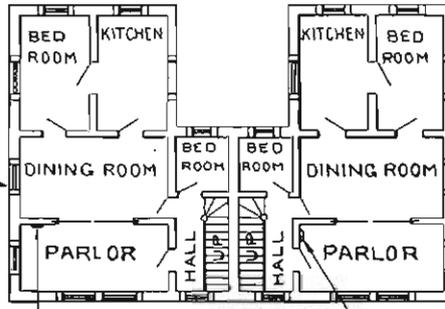

FLUSH PHONE
SEE FIG. C & D

FIG. B
AN ISOMETRIC
PERSPECTIVE
OF APARTMENT
HOUSE SHOW-
ING SYSTEM
OF PHONES &
OUTLET BOXES

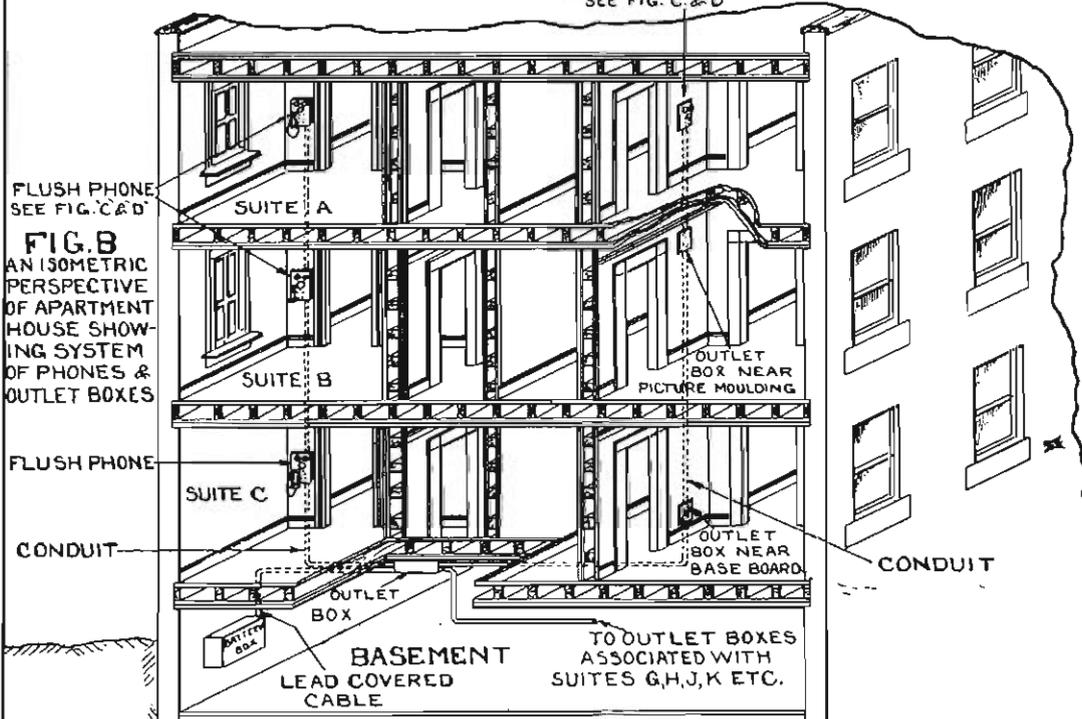

FIG. C
SECTION OF
WALL SHOWING
FLUSH PHONE
WITH MULTIPLE
UNIT TERMINAL
STRIP

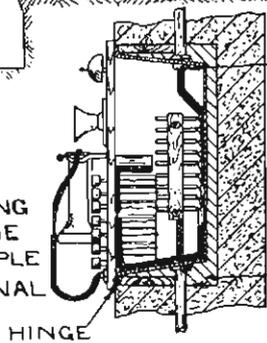
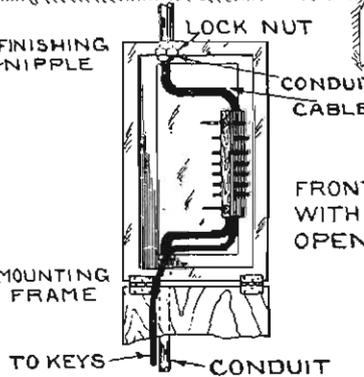
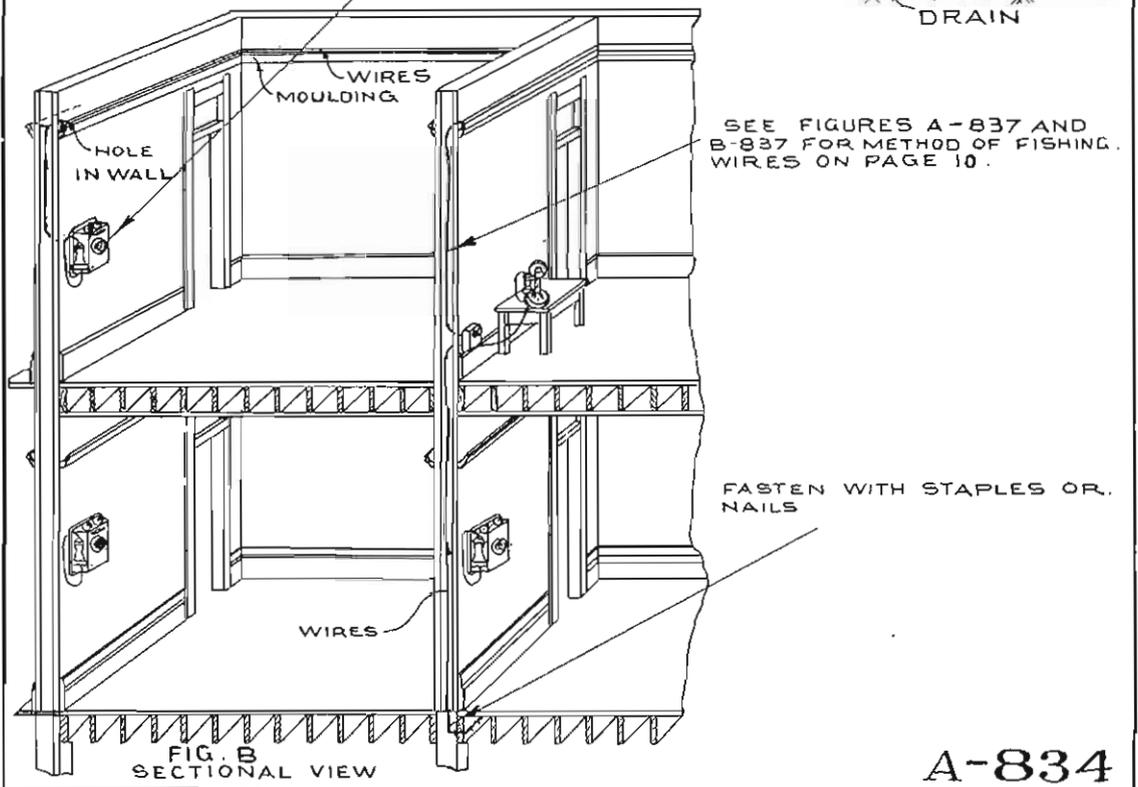
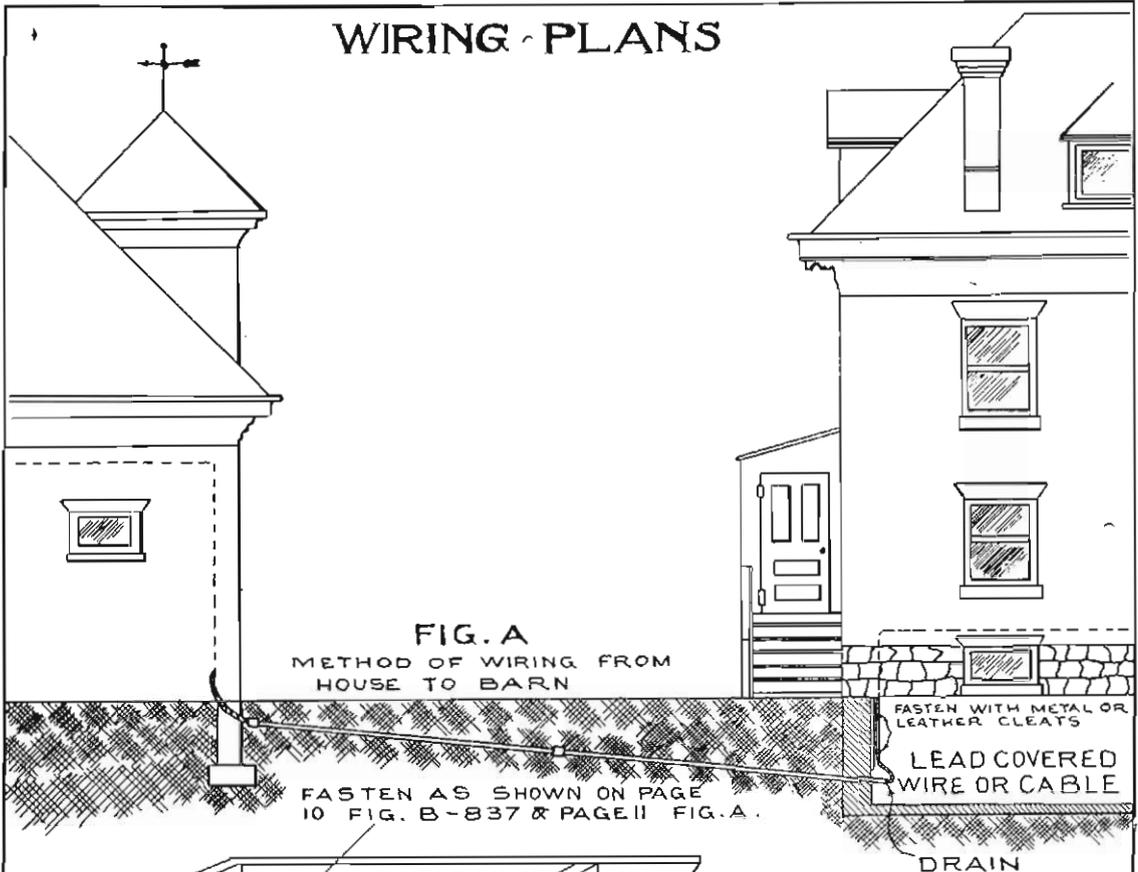

FIG. D
FRONT VIEW OF FLUSH PHONE
WITH TELEPHONE COVER
OPEN.



WIRING PLANS



A-834

CABLING PLANS DETAILS. FOR OFFICE BUILDINGS.

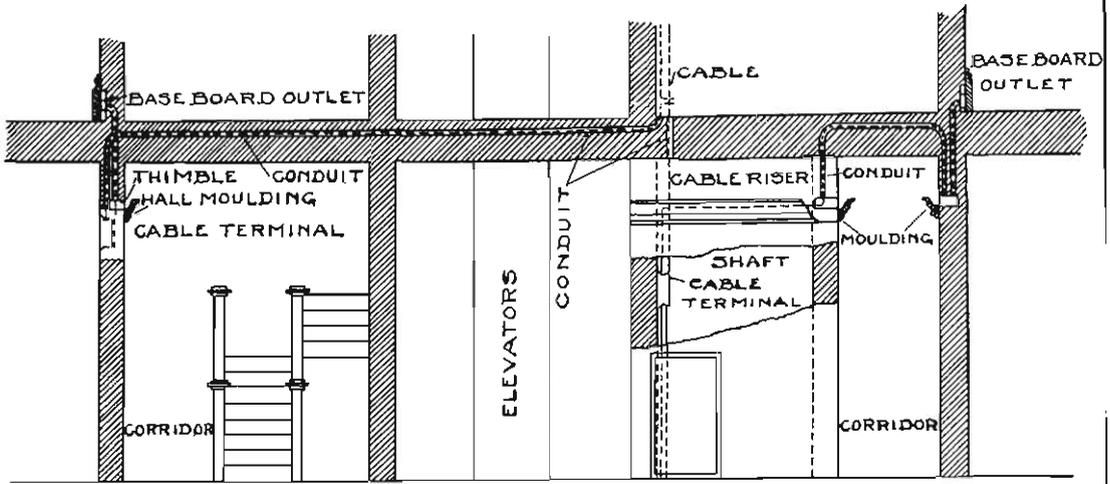

A-835

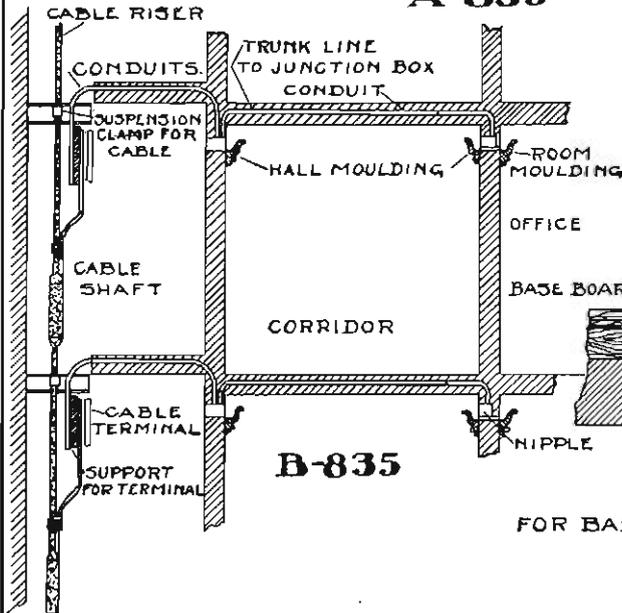

B-835

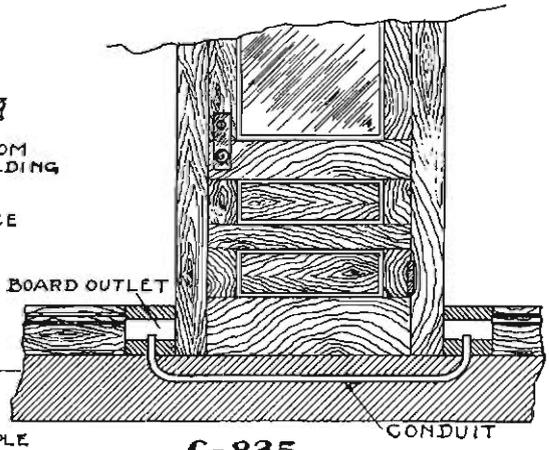

C-835

CONDUIT UNDER DOORWAY
FOR BASE BOARD DISTRIBUTING SYSTEM.

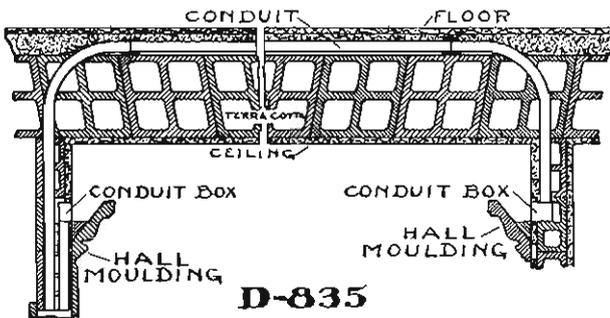

D-835

METHOD OF PLACING IRON
CONDUIT ACROSS CEILING OF HALL.

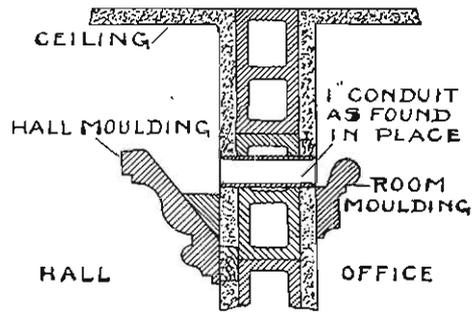

E-835

CROSS SECTION OF PARTITION.

CABLING DETAILS

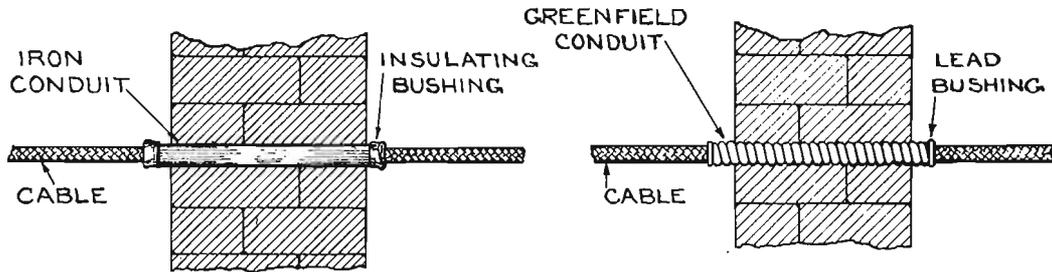

A-836

B-836

METHODS OF PROTECTING CABLES PASSING THROUGH BRICK OR STONE WALLS.

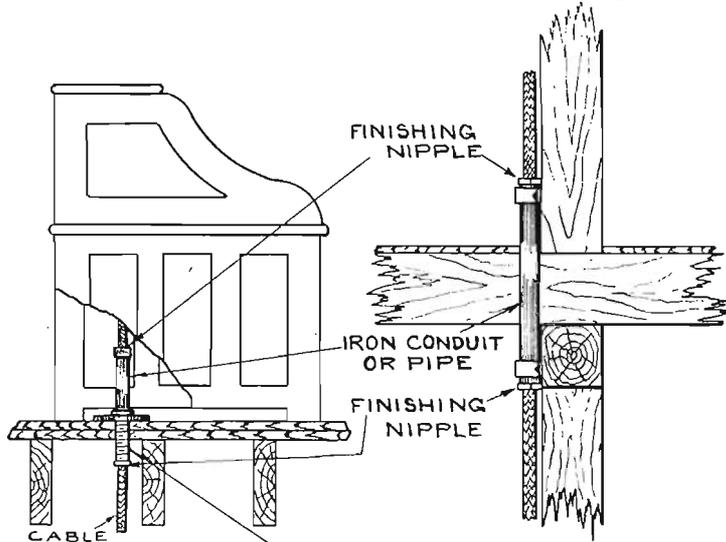

C-836 THREADED PORTION OF PIPE **D-836**

METHOD OF PROTECTING CABLES PASSING THROUGH FLOORS, UNDER DESK.

METHOD OF PROTECTING CABLE PASSING THROUGH FLOOR.

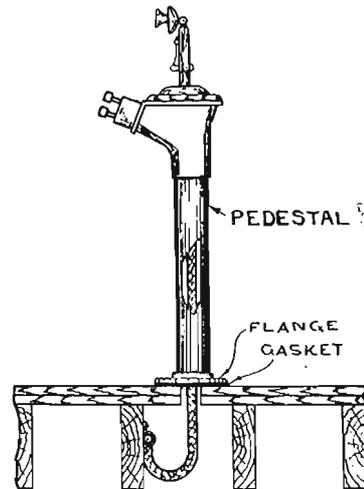

E-836

METHOD OF BRINGING CABLE THROUGH FLOOR INTO PEDESTAL

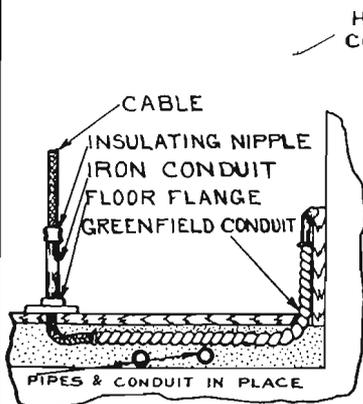

F-836

PROTECTION OF CABLE WHERE SPACE IS LIMITED

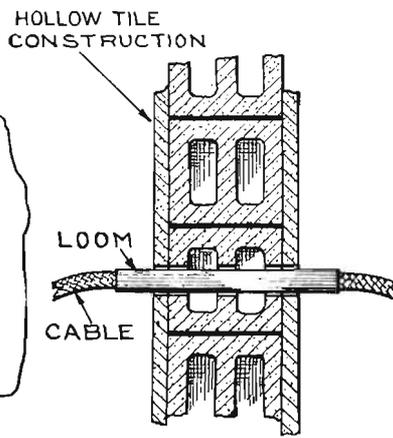

G-836

THIS MODE OF PROTECTION IS SIMILAR IN PLASTER PARTITIONS

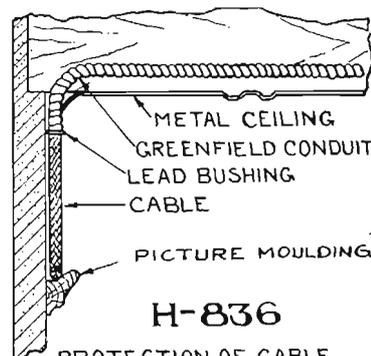

H-836

PROTECTION OF CABLE PASSING THROUGH METAL CEILING

WIRING DETAILS

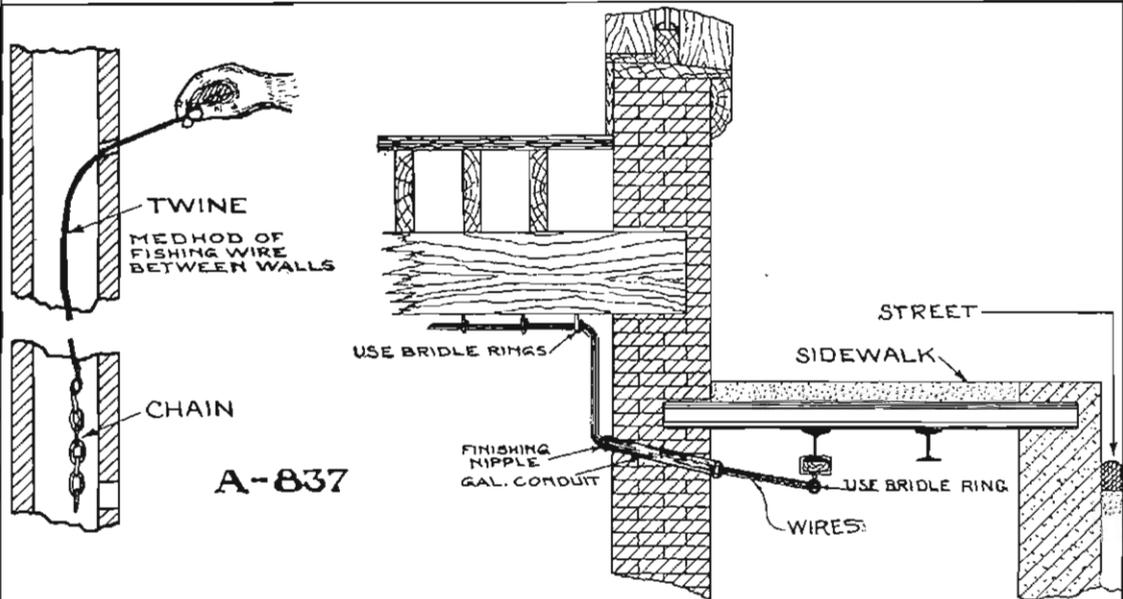

SHOWING METHOD OF CARRYING WIRES FROM SPACE UNDER SIDEWALK, THROUGH WALL, INTO BASEMENT UNDER BUILDING.

C-837

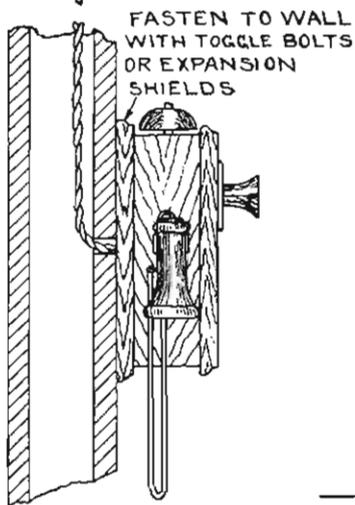
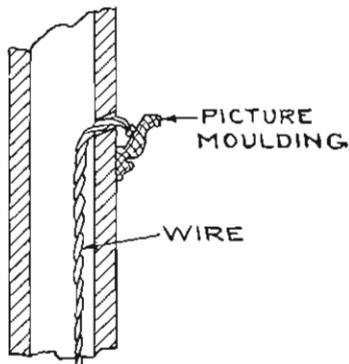

B-837

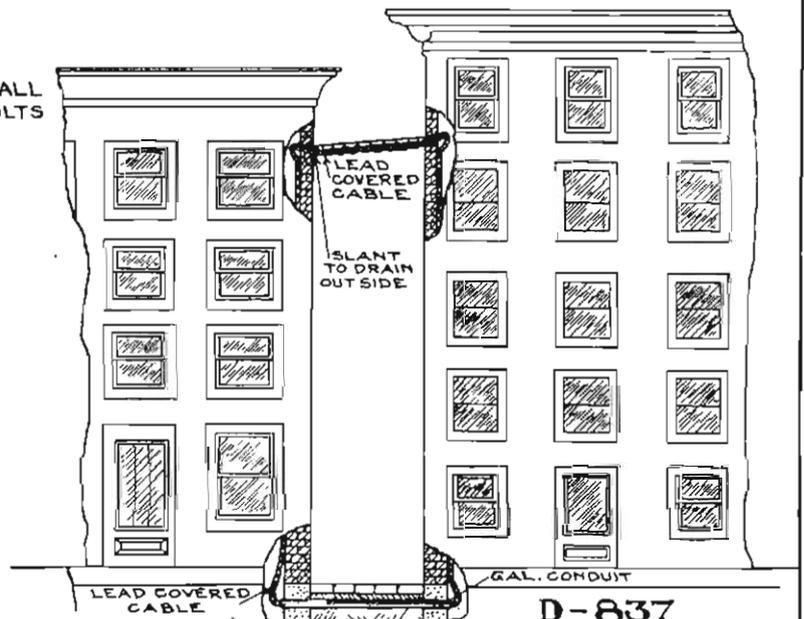

SHOWING AERIAL AND UNDERGROUND METHODS OF CONNECTING SYSTEMS OF TWO BUILDINGS EITHER METHOD MAY BE USED.

METHODS OF FASTENING PHONES.

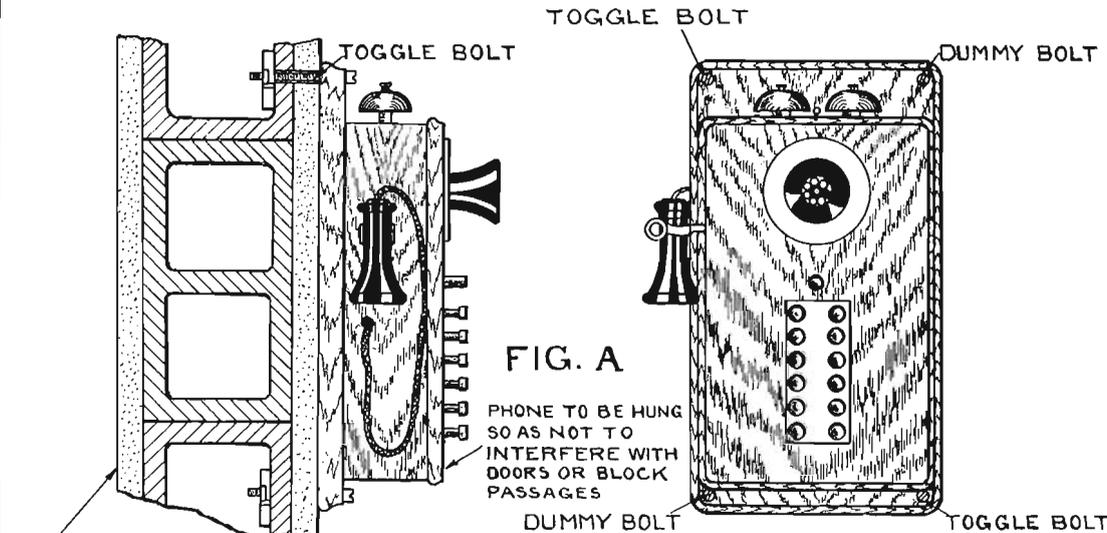

FIG. A

PHONE TO BE HUNG SO AS NOT TO INTERFERE WITH DOORS OR BLOCK PASSAGES

WALL SHOULD BE FREE FROM DAMPNESS AND VIBRATION

NOTE- TWO TOGGLE BOLTS SUFFICIENT FOR STRENGTH DUMMY BOLTS USED IN ORDER TO PRESERVE SYMMETRICAL APPEARANCE

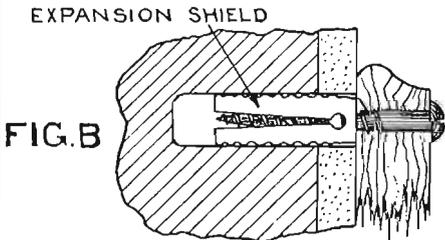
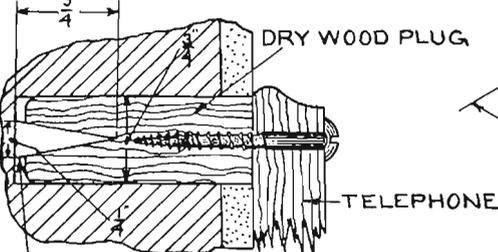

FIG. B

METHOD OF ATTACHING PHONE TO BRICK WALL WITH WOOD SCREWS AND " EXPANSION SHIELD



WEDGE SET IN SAW-CUT IN PLUG PLUG EXPANDED BY WEDGE WHEN PLUG IS DRIVEN IN.

FIG. C

METHOD OF ATTACHING PHONE TO BRICK WALL WITH WOOD SCREW AND PEG

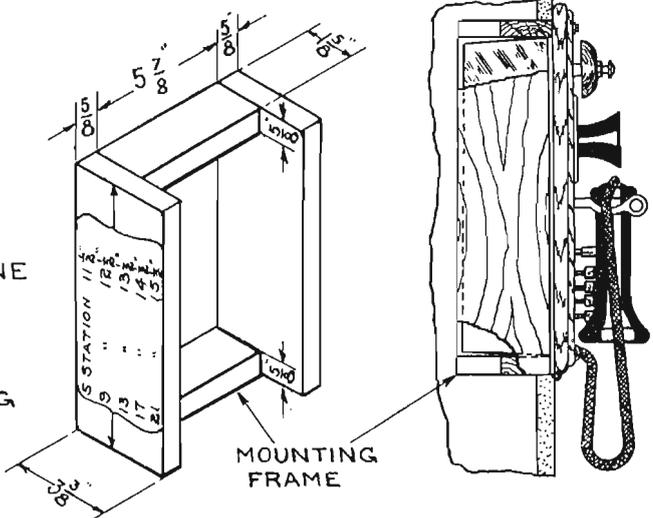
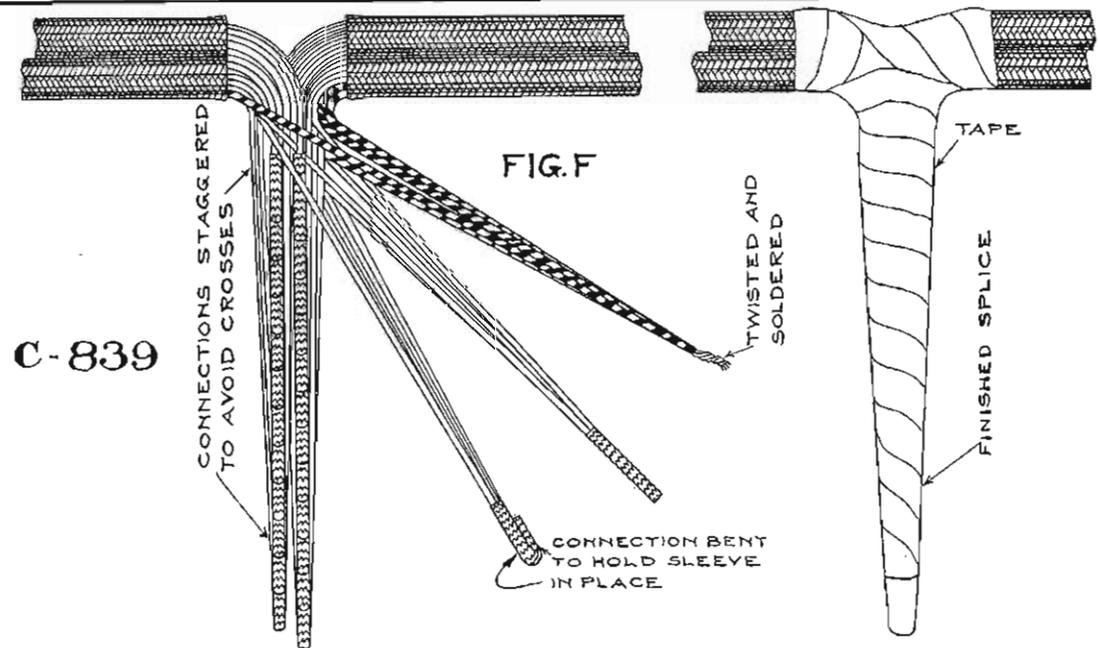
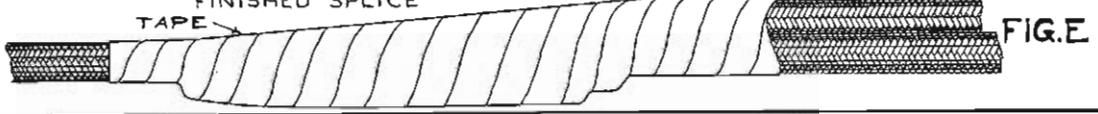
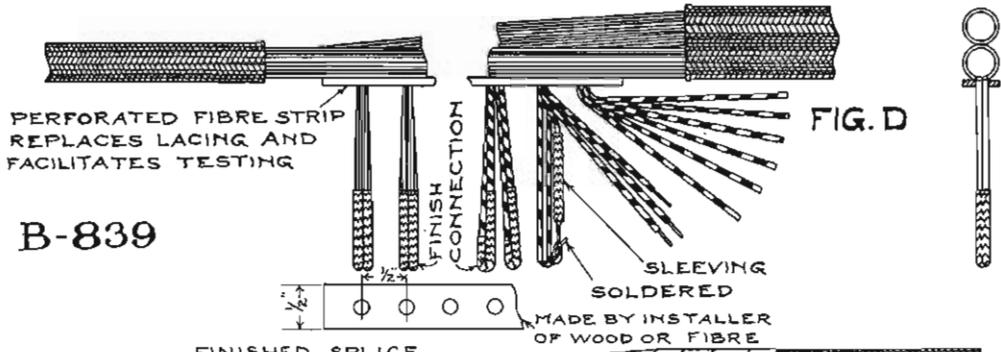
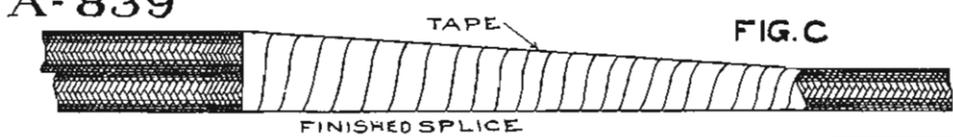

FIG. D
METHOD OF MOUNTING FLUSH PHONES

CABLE SPLICES



C-839

CABLE STRIPPING BUTTING AND FORMING

STRIPPING BRAIDED CABLE.

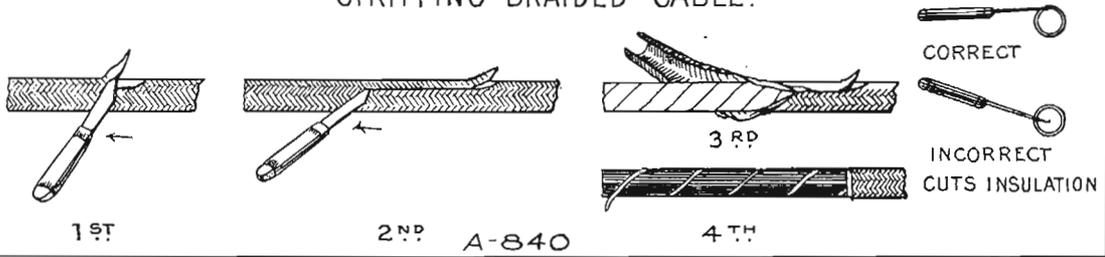

STRIPPING LEAD-COVERED CABLE

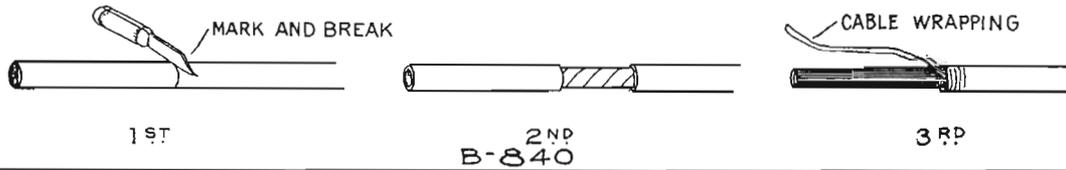

BUTTING LEAD-COVERED CABLE.

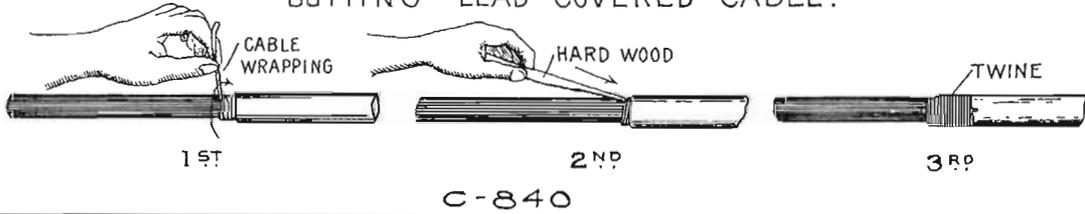

BUTTING BRAIDED CABLE

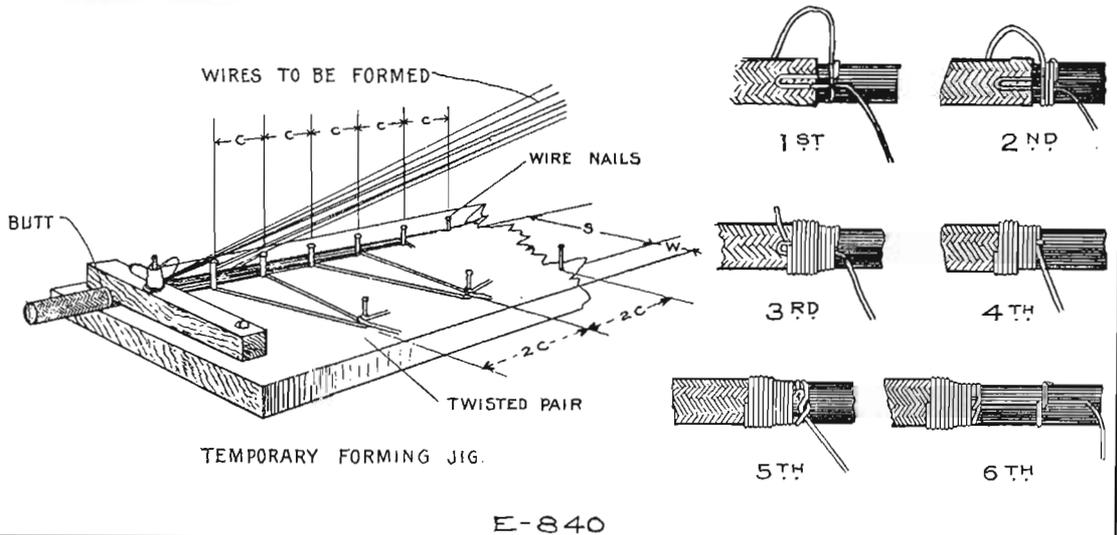
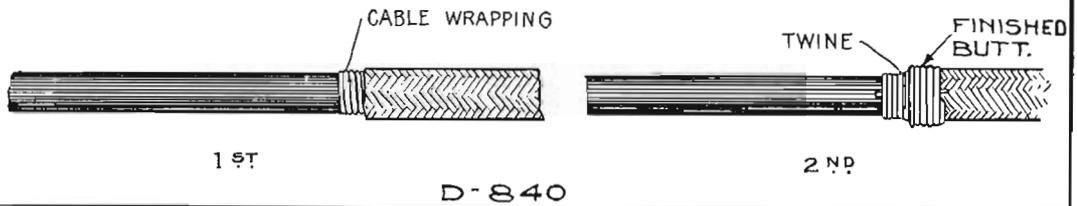

SKINNING WAXING AND SOLDERING OPERATIONS

A-841 METHOD OF SKINNING WIRE WITH PLIERS
 THE WIRE IS FIRST GRIPPED WELL UP IN THE JAWS OF THE PLIERS AND THE INSULATION IS CRUSHED. THE INSULATION AT THIS POINT IS THEN TAKEN AT THE TIP OF THE PLIERS AND HELD LIGHTLY AND IS FORCED OFF OF THE WIRE.

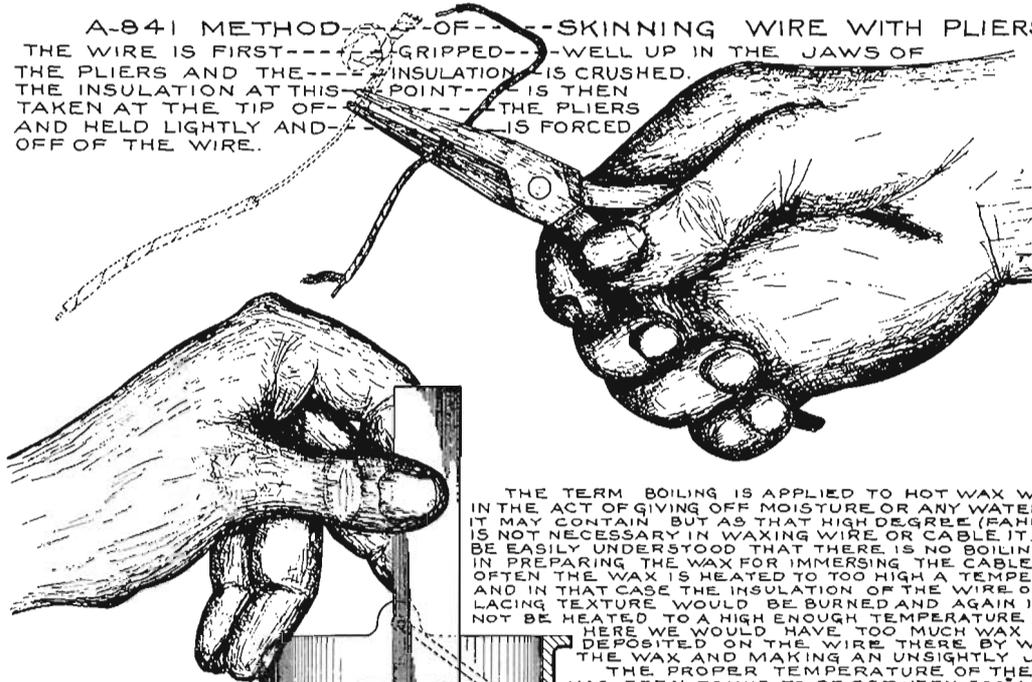

B-841 SHOWING METHOD OF PREPARING WAX FOR CABLE.

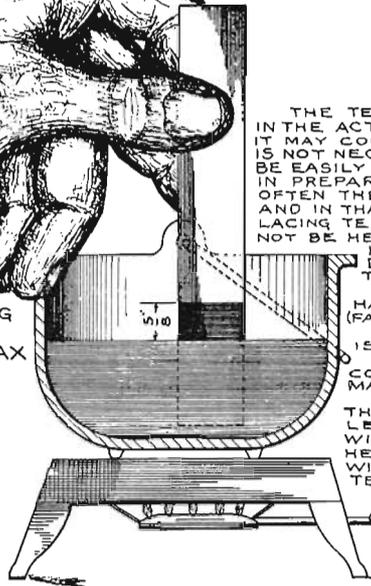

THE TERM BOILING IS APPLIED TO HOT WAX WHEN IN THE ACT OF GIVING OFF MOISTURE OR ANY WATER WHICH IT MAY CONTAIN BUT AS THAT HIGH DEGREE (FAHRENHEIT) IS NOT NECESSARY IN WAXING WIRE OR CABLE IT CAN BE EASILY UNDERSTOOD THAT THERE IS NO BOILING POINT IN PREPARING THE WAX FOR IMMERSING THE CABLE. OFTEN THE WAX IS HEATED TO TOO HIGH A TEMPERATURE AND IN THAT CASE THE INSULATION OF THE WIRE OR THE LACING TEXTURE WOULD BE BURNED AND AGAIN IT MAY NOT BE HEATED TO A HIGH ENOUGH TEMPERATURE FOR HERE WE WOULD HAVE TOO MUCH WAX DEPOSITED ON THE WIRE THERE BY WASTING THE WAX AND MAKING AN UNSIGHTLY JOB. THE PROPER TEMPERATURE OF THE WAX HAS BEEN FOUND TO BE BETWEEN 360° AND 375° (FAHRENHEIT)

A SIMPLE TEST TO FIND THE PROPER HEAT IS SHOWN IN THE ILLUSTRATION.

A STRIP OF WRAPPING OF NEWS PAPER OF A CONVENIENT WIDTH IS TAKEN AND A POINT IS MARKED UPON IT WITH A PENCIL.

THE PAPER IS THEN THRUST DOWN INTO THE HOT WAX UNTIL THE PENCIL MARK IS ON A LEVEL WITH THE TOP OF THE WAX. THE PAPER WILL ABSORB THE WAX UPON ITS SURFACE TO A HEIGHT OF 1/8 OF AN INCH AND THIS CONDITION WILL SHOW THAT THE WAX IS AT THE PROPER TEMPERATURE FOR IMMERSING CABLES.

C-841

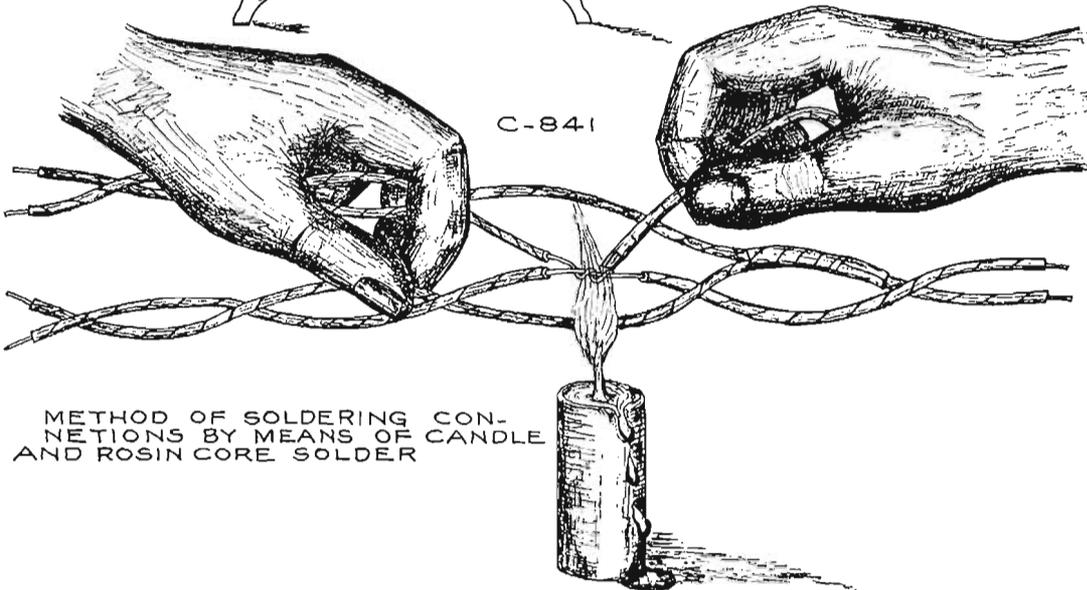

METHOD OF SOLDERING CONNECTIONS BY MEANS OF CANDLE AND ROSIN CORE SOLDER

BATTERY BOXES

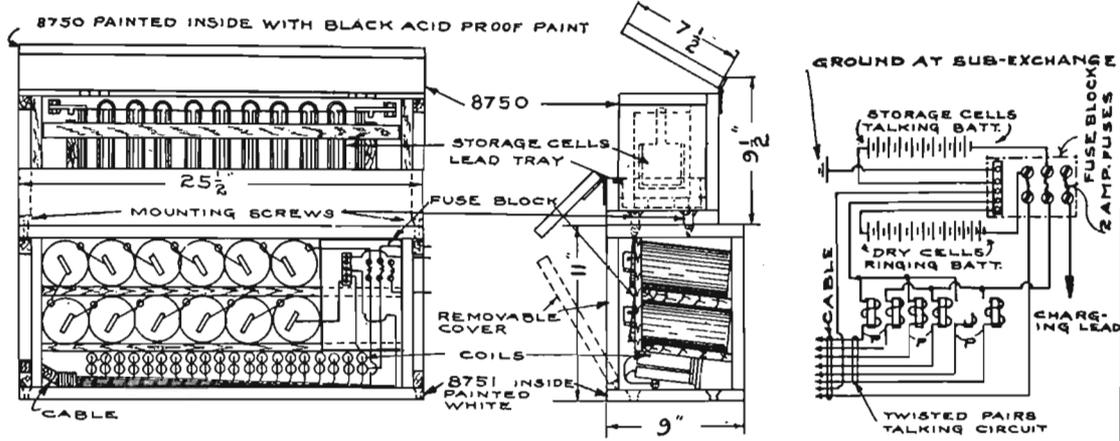

USED WITH SYSTEMS OPERATING IN CONNECTION WITH COMMON BATTERY EXCHANGES.
 OUTSIDE CHESTNUT, NATURAL FINISH. 8750 AND 8751 ARE BUILT IN SEPARATE UNITS.
FIGURES 8750 AND 8751

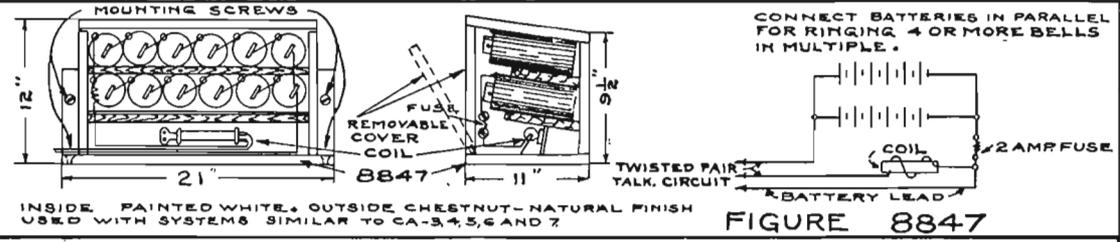

INSIDE PAINTED WHITE, OUTSIDE CHESTNUT-NATURAL FINISH
 USED WITH SYSTEMS SIMILAR TO CA-3,4,5,6 AND 7

FIGURE 8847

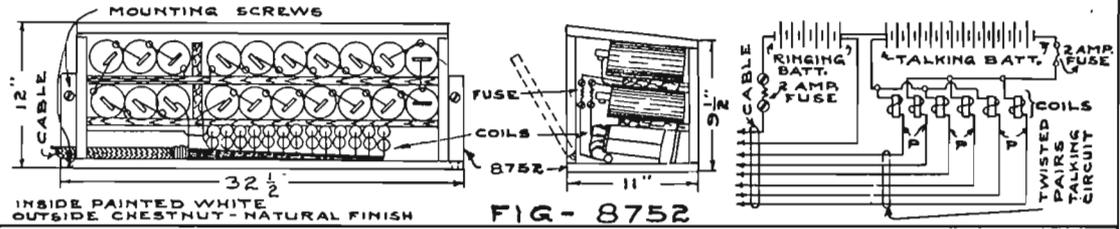

INSIDE PAINTED WHITE
 OUTSIDE CHESTNUT-NATURAL FINISH

FIG- 8752

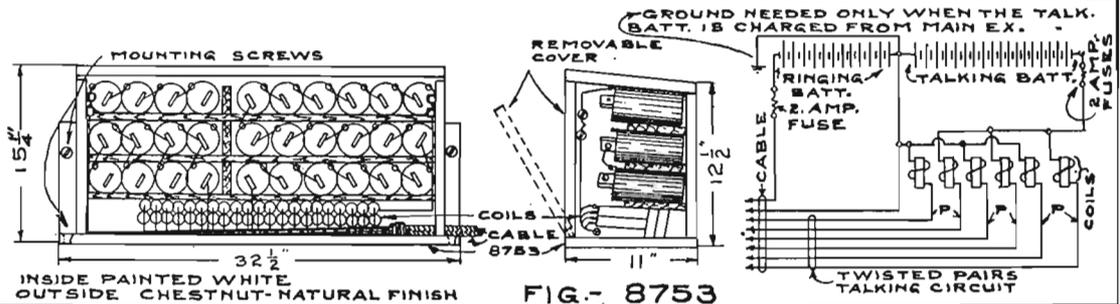

INSIDE PAINTED WHITE
 OUTSIDE CHESTNUT-NATURAL FINISH

FIG.- 8753

NOTE:-
 AMPLE SPACE IS PROVIDED IN THESE BOXES FOR DISTRIBUTING THE CABLE FROM EITHER END OR THROUGH THE BOTTOM OF THE BOX.
 COILS AND BATTERIES NOT FURNISHED WITH BATTERY BOXES.
 INSTALL BATTERY BOXES IN A DRY PLACE. DRY BATT. INSTALLED AT PLACES WHERE INSPECTION CAN ONLY BE MADE AT CERTAIN INTERVALS AND CONSIDERABLE EXPENSE CELLS MAY BE PACKED IN DRY SAWDUST TO REDUCE EVAPORATION AND THEREBY INCREASE THE LIFE OF THE CELLS

CODE NO.	NO. OF VOLT. OF CELLS TALKING	NO. OF VOLT. OF CELLS RINGING	NO. OF VOLT. OF CELLS AGE	CELL CAPACITY OF BOX	PRICE	REMARKS	CODE NO.	NO. OF VOLT. OF CELLS TALKING	NO. OF VOLT. OF CELLS RINGING	NO. OF VOLT. OF CELLS AGE	CELL CAPACITY OF BOX	PRICE	REMARKS	
8847	6	9		12	\$5.00	SEE NOTE "A"	8752	14	20	6	9	20	\$7.50	NO. OF CELLS IN TALK. BATTERY
8751			12	18	\$7.50	RING. BATT.	8753	18	27	12	18	30	\$7.50	NO. OF CELLS IN TALK. BATTERY
8750	10	STORAGE CELLS			\$10.00	TALK. BATT.	NOTE "A" SAME BATT. USED FOR RING. AND TALK.							

BRACKET & PEDESTAL

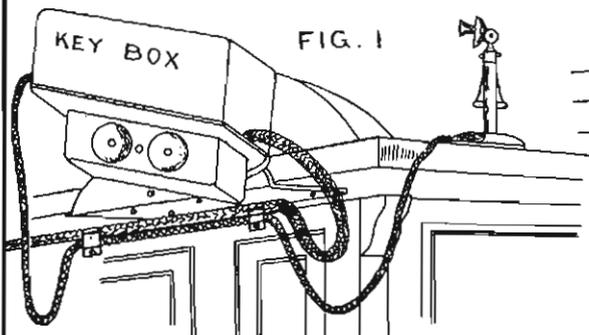

BRACKET SHOWN ON L.H. SIDE
ROLL TOP DESK

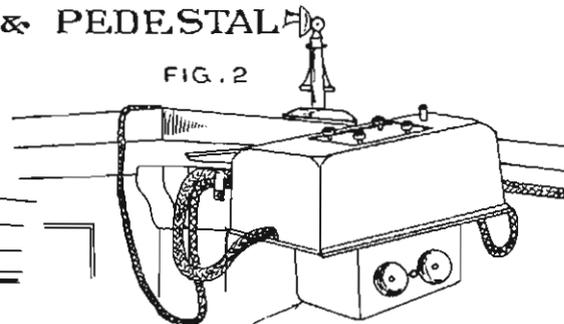

HINGED TO ALLOW
ADJUSTMENTS

BRACKET SHOWN ON R.H. SIDE
OF FLAT TOP DESK

FIG. 3

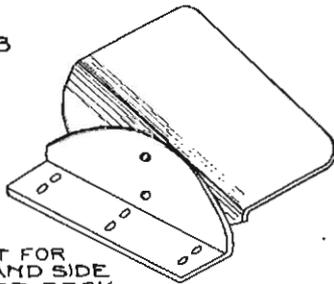

BRACKET FOR
RIGHT HAND SIDE
ROLL TOP DESK

FIG. 4

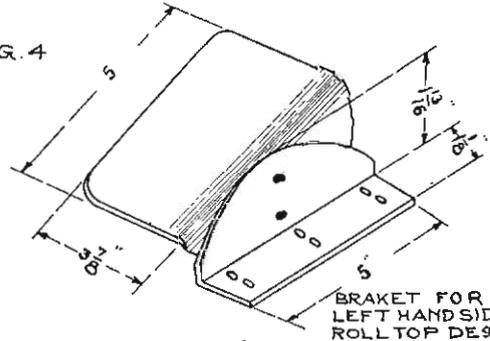

BRACKET FOR
LEFT HAND SIDE
ROLL TOP DESK

FIG. 5

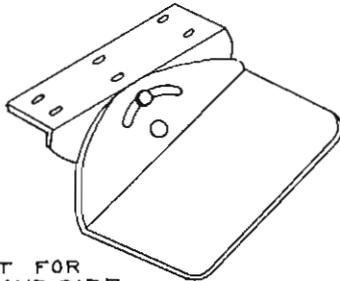

BRACKET FOR
RIGHT HAND SIDE
FLAT TOP DESK

THIS BRACKET CAN
BE MOUNTED IN
POSITIONS SHOWN
IN FIGS. 3, 4, 5, 6.

FIG. 6

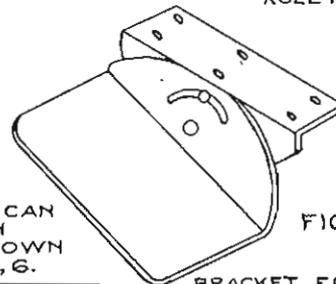

BRACKET FOR
LEFT HAND SIDE
FLAT TOP DESK

UNIVERSAL BRACKET

CODE NO.	PRICE
8848	2.00

ATTENDANT'S STATION
FLAT TOP DESK.

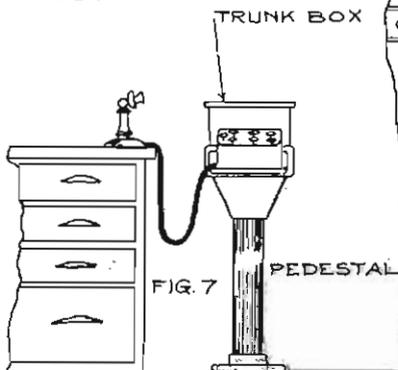

FIG. 7

PEDESTAL

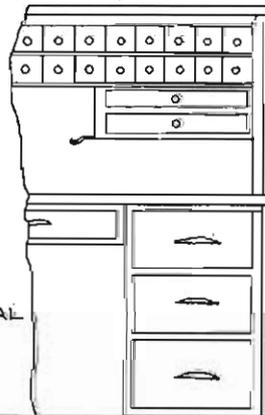
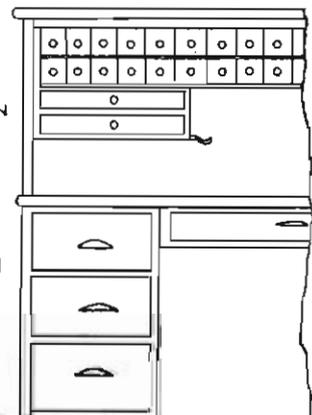

FIG. 8
LOCAL STATION



STAND SHOWN BETWEEN
TWO DESKS.

CODE NO.	DESCRIPTION	PRICE
8849	PEDESTAL	6.00

JUNCTION BLOCKS

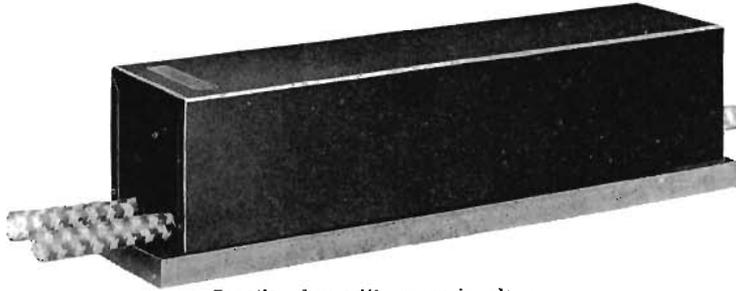

Junction box with cover in place.

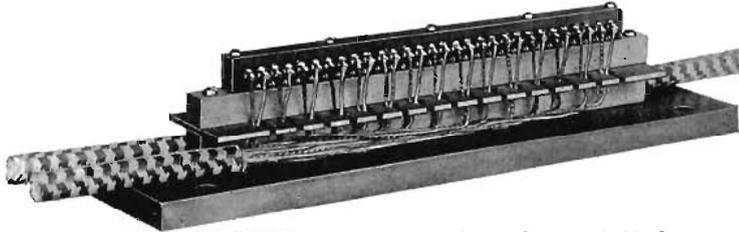

Open view showing neat connections easily made on this block.

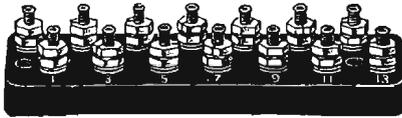

Lock Nut Connecting Rack.



Sperry Standard Bracket.

The junction block used in connection with Kellogg Automatic Interior Telephone Systems is durably built and all connections can be easily made. The base board is of seasoned wood, finished and drilled for mounting screws. The terminal strip is of well-seasoned maple and of sufficient thickness to allow space for cables between the base and fanning strip. The fanning strip holds the cable pairs in place and does away with lacing cables. Another maple strip is placed above the fanning strip to give proper space to the terminals which are mounted securely in hard rubber. The terminals are arranged for all soldered connections or for three soldered and one screw connections. This construction makes every part accessible and permits instant inspection.

The cover for this junction block is of steel, durably black enameled, and is sufficiently heavy to protect the terminals.

LOCK NUT CONNECTING RACK

The lock nut connecting rack is used for heavy gauged wires and where no soldered connections are desired. It is durably constructed and terminals are placed in such a position as to simplify connection.

SPERRY BRACKET

The Sperry Telephone Bracket can be used with any of the desk telephone type systems.

This bracket keeps the telephone off of the desk and out of your way, yet within easy reach. A slight pull places the telephone in talking position and after the conversation, a slight push places it out of your way but instantly available for the next call. No disarranged papers, over-turned ink wells or similar disturbances.

The Sperry Bracket is constructed of the highest grade materials and operated on the approved gate type principle. It will not sag. It is guaranteed for five years. A size to suit every demand.

KELLOGG SWITCHBOARD AND SUPPLY COMPANY, CHICAGO

Code No. Braided Cable	\$209-A	\$213-A	\$217-A	\$221-A	\$225-A						Color Scheme	Number Index Wire	Color of Twisted Mate
Code No. Leaded Cable	\$209-L	\$213-L	\$217-L	\$221-L	\$225-L	\$109-L	\$113-L	\$117-L	\$121-L	\$124-L			
No. Pairs 22 Ga.	9	13	17	21	25								
No. Single 22 Ga.						9	13	17	21	25			
No. Pairs 16 Ga.	1	1	1	1	1	1	1	1	1	1			
X	X	X	X	X	X	X	X	X	X	X	Blue	1	White
X	X	X	X	X	X	X	X	X	X	X	Orange	2	"
X	X	X	X	X	X	X	X	X	X	X	Green	3	"
X	X	X	X	X	X	X	X	X	X	X	Black	4	"
X	X	X	X	X	X	X	X	X	X	X	Slate	5	"
X	X	X	X	X	X	X	X	X	X	X	Blue & White	6	"
X	X	X	X	X	X	X	X	X	X	X	Blue & Orange	7	"
X	X	X	X	X	X	X	X	X	X	X	Blue & Green	8	"
	X	X	X	X		X	X	X	X	X	Blue & Black	9	"
	X	X	X	X		X	X	X	X	X	Blue & Slate	10	"
	X	X	X	X		X	X	X	X	X	Orange & White	11	"
	X	X	X	X		X	X	X	X	X	Orange & Green	12	"
		X	X	X		X	X	X	X	X	Orange & Black	13	"
		X	X	X		X	X	X	X	X	Orange & Slate	14	"
		X	X	X		X	X	X	X	X	Green & White	15	"
		X	X	X		X	X	X	X	X	Green & Black	16	"
			X	X		X	X	X	X	X	Green & Slate	17	"
			X	X		X	X	X	X	X	Black & White	18	"
			X	X		X	X	X	X	X	Black & Slate	19	"
			X	X		X	X	X	X	X	Slate & White	20	"
				X		X	X	X	X	X	Blue & Red	21	"
				X		X	X	X	X	X	Orange & Red	22	"
				X		X	X	X	X	X	Green & Red	23	"
				X		X	X	X	X	X	Black & Red	24	"
X	X	X	X	X	X	X	X	X	X	X	BLUE, ORANGE & WHITE	25	"
X	X	X	X	X	X	X	X	X	X	X	Red	26	"

The above is a color scheme from which all cables should be formed. For example:—System No. 1 requiring cable for an 8 station set, has "X" marks in first column. No. 1 pair is Blue, No. 2 Orange, No. 3 Green, etc., down to and including Blue Green. Battery pair is always Red with White mate. Spare or extra pair is Blue, Orange and White.

Common return cables have no white mates as only single conductors are used for line wires.

Code Nos. shown are for cable made with 2 silk and 1 cotton insulation.

DIMENSIONAL DRAWINGS

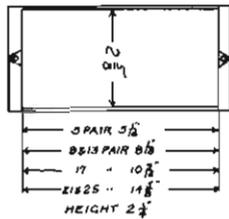

Diagram 1, showing the dimensions of the standard junction boxes furnished with all of our systems.

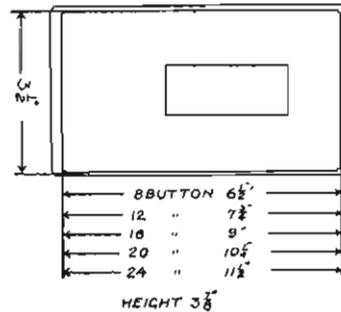

Diagram 2, showing the dimensions of the standard size key boxes furnished in Systems 1 and 3.

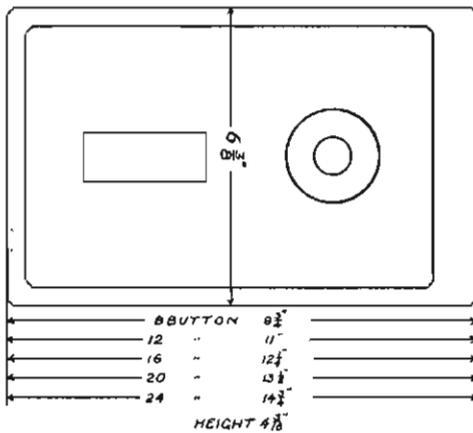

Diagram 3, showing the dimensions of the standard sizes of steel wall telephones furnished in Systems 1, 2 and 3.

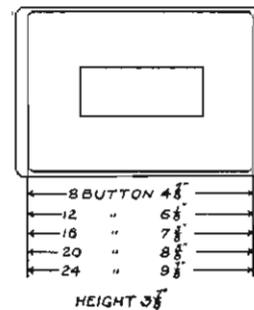

Diagram 4, showing the dimensions of the standard size key box furnished in Systems 2 and 4.